

# Profilsystem für Textilbanner



SF Rahmen



SF Ausstellung

**SYSTEM  
STANDEX®**

### ■ System Standex tilbyder:

Komplette rammer til stofbanner.

Komplette LED lysrammer til stofbanner.

Rammerne kan anvendes i butikker, udstillinger, showroom og mange andre steder.

Til den professionelle udstillingsvirksomhed og butiksyndretter, kan vi tilbyde profiler skåret på mål – eller leveret i hele længder for egen bearbejdning.

Kontakt os for yderligere information.

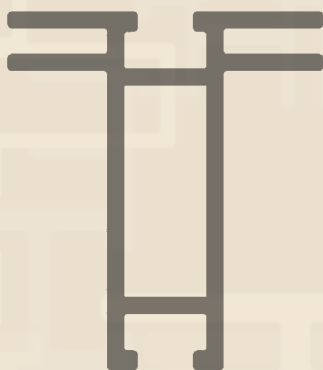

### ■ System Standex manufactures:

Frames for fabric graphics – non illuminated or complete with LED illumination.

Frames for in store displays – exhibitions – showrooms and promotions.

We offer the systems in component form or cut and machined to size ready for assembly.

Contact us for more information.

### ■ System Standex bietet:

Komplette Rahmen für Textilbanner.

Komplette Rahmen mit LED Beleuchtung für Textilbanner.

Die Rahmen können in Läden, auf Aufstellungen in Ausstellungsräume u.s.w. verwendet werden.

Für den professionellen Messebauer und Ladenbauer, können wir die Profile abgelängt anbieten oder in vollen Längen für die eigene Bearbeitung.

Kontakten Sie uns für mehr Information.

# Inhaltsverzeichnis:

Große LED Leuchtrahmen .....	4
Schlanke LED Rahmen .....	6
Einseitige Rahmen .....	8
Beidseitige Rahmen.....	10
Würfelbau und Stützenabdeckungen .....	12
Profile für Textilbanner .....	13
Verbinder .....	14
Fußplatten .....	15
Stützzargen für Rahmen .....	16
Rahmen für Ausstellungen mit SF-HANDLE .....	17
Beispiele von Ausstellungen .....	19
Zubehör für Ausstellungsrahmen .....	20
Supermagnetsystem.....	21
Zubehör für Schienen .....	22
Leuchtkastenprofil für Schienensystem .....	23
TV-Halterung und LED-Beleuchtung von einem Teil des Rahmens ....	24
Technische information.....	25
EasyCase Transportkisten .....	26
Foto-Galerie.....	27

# Large light boxes

- Store LED-lysrammer til stofprint
- Large LED light boxes for fabric graphics
- Große LED Leuchtrahmen für Textilbanner

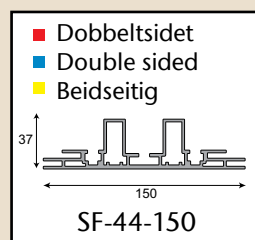
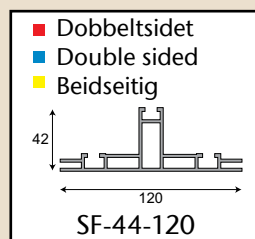
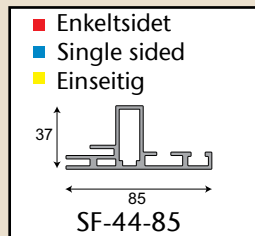

- System Standex fremstiller lyskasser i mål efter dit ønske, både enkeltsidet og dobbeltsidet. Til ophæng på væg, nedhængt fra loft eller fritstående. Kontakt os for uforpligtende tilbud.
- System Standex manufacture LED light boxes to your size and specification – single and double sided. The light boxes can be wall mounted, hanging or free standing. Please contact us for a quotation.

- System Standex stellt Leuchtrahmen in Größen laut Ihren Spezifikationen her, sowohl einseitig als beidseitig. Wandhängend, herabhängend oder freistehend. Kontaktieren Sie uns für ein unverbindliches Angebot.

- Anvendelsesmuligheder:
- Applications:
- Anwendungsmöglichkeiten:

- Fritstående:
- Free standing:
- Freistehend:

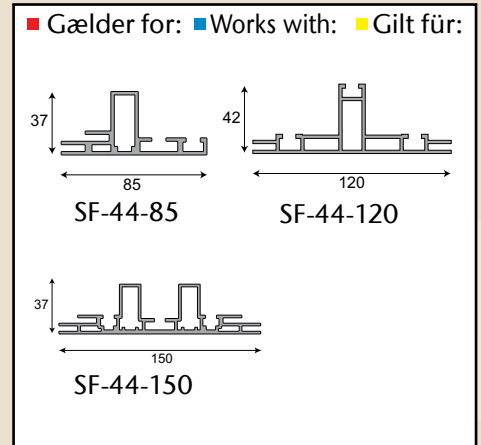

- Frithængende:
- Hanging:
- Freihängend:

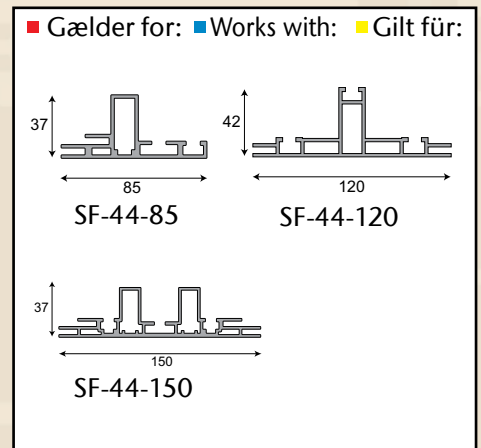
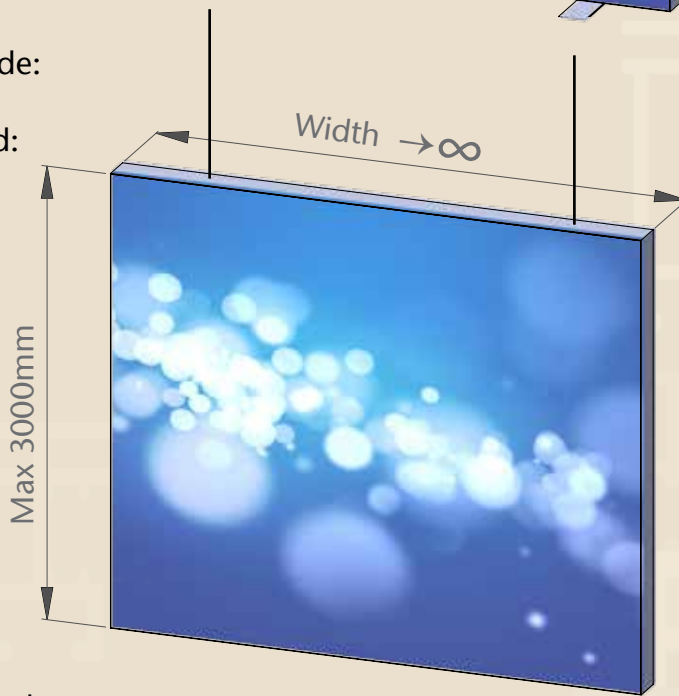

- Væghængt:
- Wall mounted:
- Wandhängend

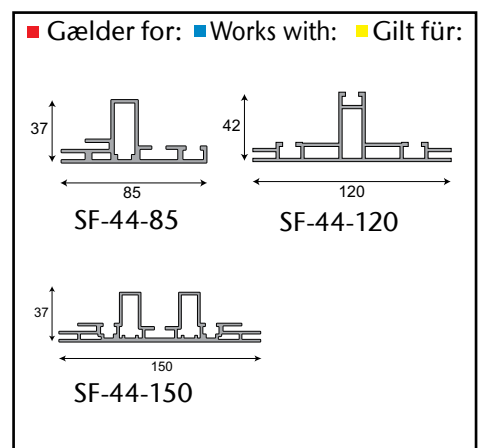



# Slim line LED frames

- Slanke LED rammer til stofprint
- Slim LED frames for fabric graphics
- Schlanke LED Rahmen für Textilbanner

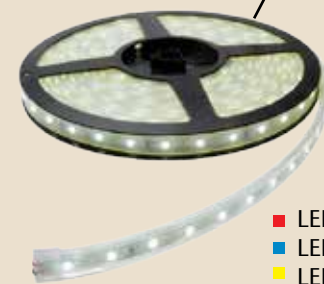
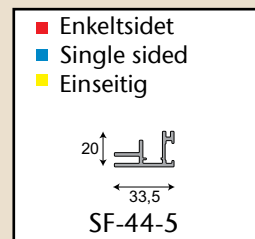
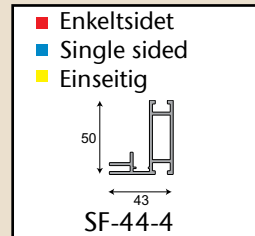

- System Standex fremstiller slanke LED lysrammer for enkelt-sided belysning i mål efter dit ønske. Lysrammer med LED bånd kan hænges på væg med beslag eller hænges ned fra loftet. Kontakt os for et uforpligtende tilbud.
- System Standex manufacture single sided slim line LED light boxes to your size and specification. The light boxes are fitted with LED strips and can be wall mounted or hanging. Please contact us for a quotation.

- System Standex stellt schlanke LED Leuchtrahmen für die einseitige Beleuchtung laut Ihrer Spezifikation her. Die Leuchtrahmen mit LED Bändern können auf der Wand auf Beschlägen hängen, und von der Decke herab. Kontaktieren Sie uns für ein unverbindliches Angebot.

- Anvendelsesmuligheder:
- Applications:
- Anwendungsmöglichkeiten:

- Fritstående:
- Free standing:
- Freistehend:

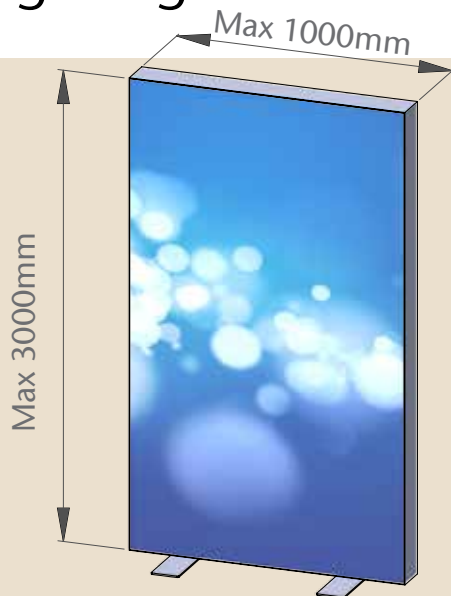

- Gælder for:
- Works with:
- Gilt für:

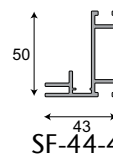

- Frithængende:
- Hanging:
- Freihängend:

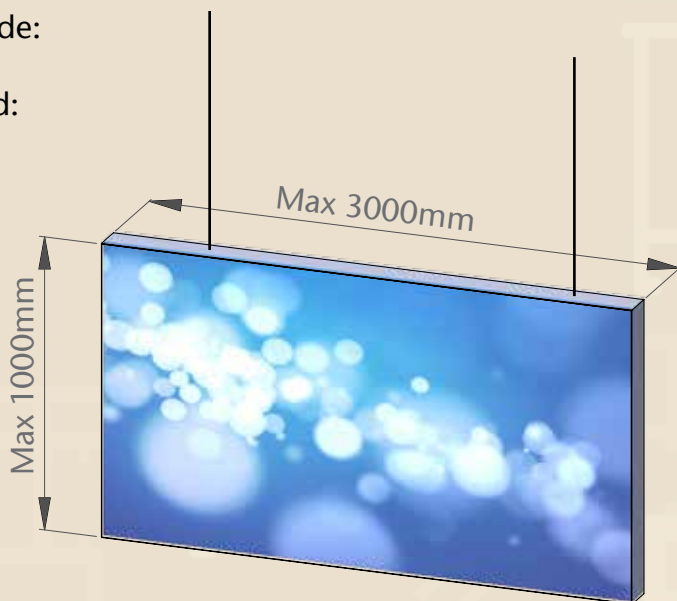

- Gælder for:
- Works with:
- Gilt für:

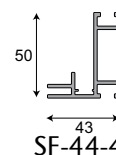

- Væghængt:
- Wall mounted:
- Wandhängend:

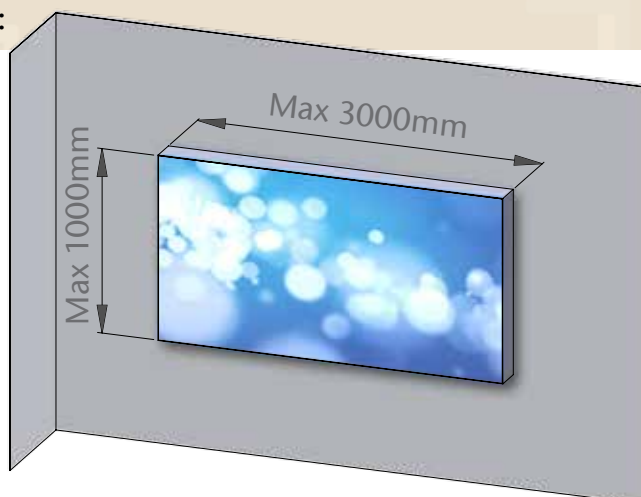

- Gælder for:
- Works with:
- Gilt für:

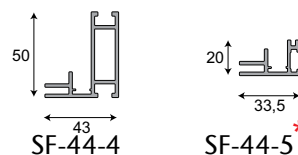

- \*Max bredde for SF-44-5 er 2000mm
- \*Max width for SF-44-5 is 2000mm
- \*Max Breite von SF-44-5 ist 2000mm

# Single sided frames

- Rammer til stofprint
- Frames for fabric graphics
- Rahmen für Textilbanner

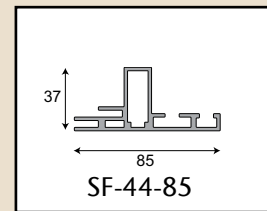
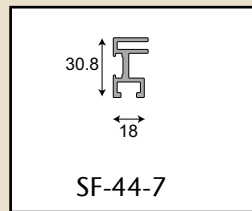
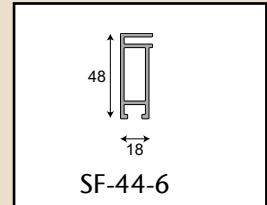
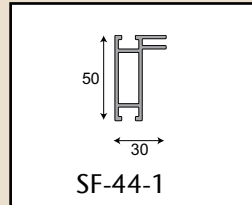

- System Standex fremstiller flere varianter af rammer til enkeltsidet stofprint – alt efter dit ønske. Rammerne kan anvendes fritstående, hængende på væg eller nedhængt fra loft. Kontakt os for et uforpligtende tilbud.
- System Standex offer a range of profiles for single sided frames all manufactured to your size and specification. These frames can be free standing, hanging or wall mounted. Please contact us for a quotation.

- System Standex stellt verschiedene Rahmen für die einseitige Textilbespannung her – je nach Ihren Spezifikationen. Die Rahmen können frei stehen, auf der Wand hängen oder von der Decke herab. Kontaktieren Sie uns für ein unverbindliches Angebot.



- Anvendelsesmuligheder:
- Applications:
- Anwendungsmöglichkeiten:

- Fritstående:
- Free standing:
- Freistehend:



■ Gælder for: ■ Works with: ■ Gilt für:

SF-44-1      SF-44-85

- Frithængende:
- Hanging:
- Freihängend:

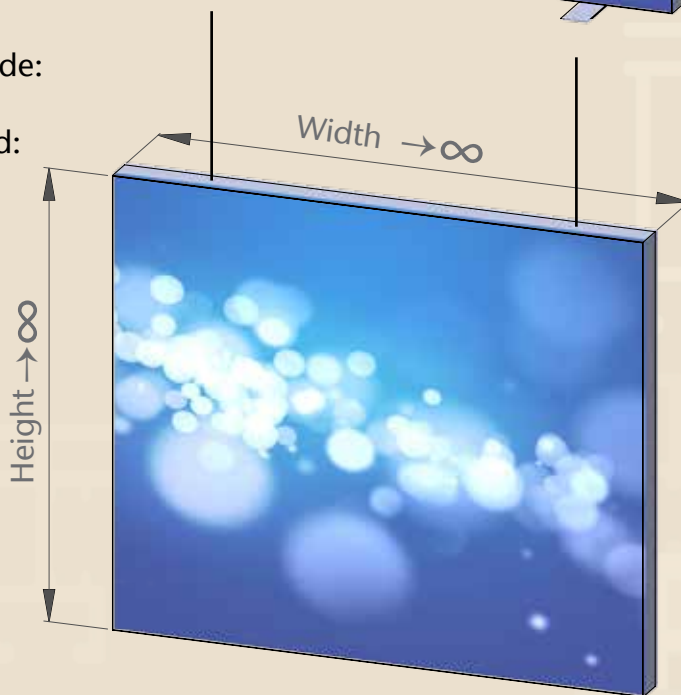

■ Gælder for: ■ Works with: ■ Gilt für:

SF-44-1      SF-44-85

- Væghængt:
- Wall mounted:
- Wandhängend:

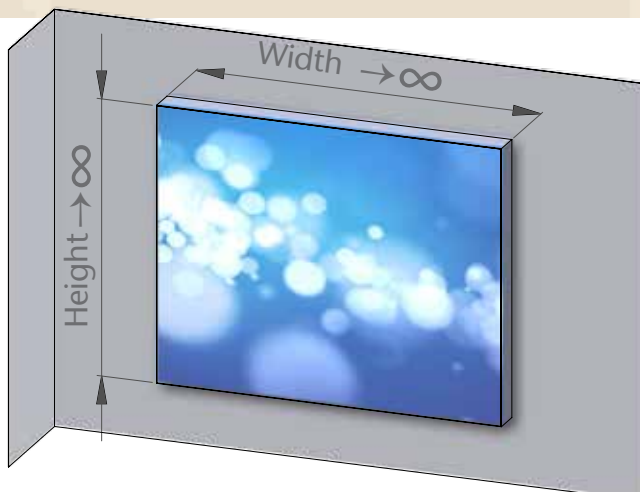

■ Gælder for: ■ Works with: ■ Gilt für:

SF-44-1      SF-44-6

SF-44-85      SF-44-7\*

- \*Max bredde for SF-44-7 er 1200mm og max højde er 1200mm
- \*Max width for SF-44-7 is 1200mm and max height is 1200mm
- \*Max Breite für SF-44-7 ist 1200mm und max Höhe ist 1200mm

# Double sided frames

- Rammer til stofprint
- Frames for fabric graphics
- Rahmen für Textilbanner

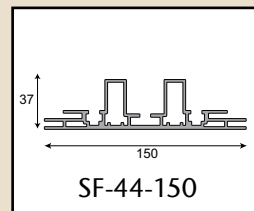
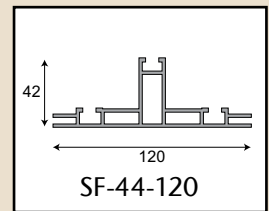
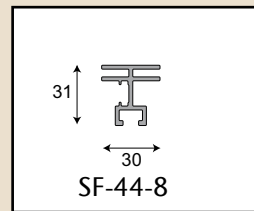
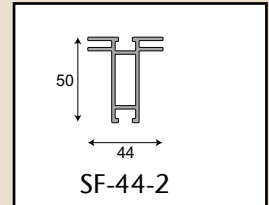
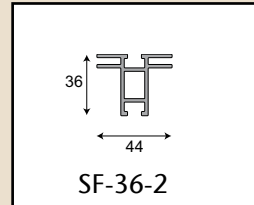

■ System Standex fremstiller flere varianter af rammer til dobbeltsidet stofprint – på mål efter dit ønske. Rammerne kan anvendes fritstående, indbygget i væg eller nedhængt fra loft. Kontakt os for et uforpligtende tilbud.

■ System Standex offer a range of profiles for double sided frames all manufactured to your size and specification. These frames can be free standing, hanging or built into a wall or partition. Please contact us for a quotation.

■ System Standex stellt verschiedene Rahmen für die beidseitige Textilbespannung her – je nach Ihren Spezifikationen. Die Rahmen können frei stehen, eingebaut werden, oder von der Decke herab hängen. Kontaktieren Sie uns für ein unverbindliches Angebot.

- Anvendelsesmuligheder:
- Applications:
- Anwendungsmöglichkeiten:

- Fritstående:
- Free standing:
- Freistehend:

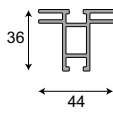
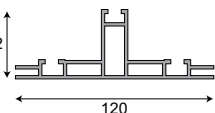
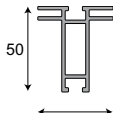
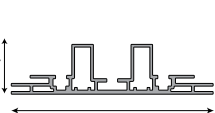

■ Gælder for: ■ Works with: ■ Gilt für:

 36 44 <b>SF-36-2</b>	 42 120 <b>SF-44-120</b>
 50 44 <b>SF-44-2</b>	 37 150 <b>SF-44-150</b>

- Frithængende:
- Hanging:
- Freihängend:

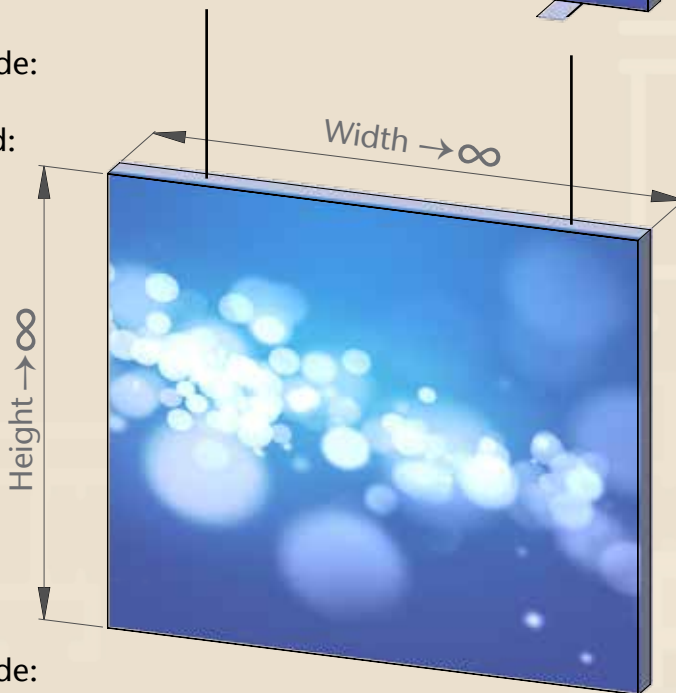

■ Gælder for: ■ Works with: ■ Gilt für:

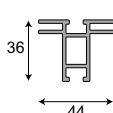
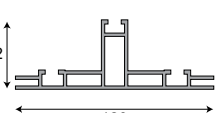
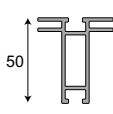
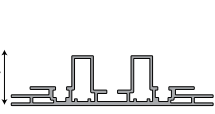
 36 44 <b>SF-36-2</b>	 42 120 <b>SF-44-120</b>
 50 44 <b>SF-44-2</b>	 37 150 <b>SF-44-150</b>

- Frithængende:
- Hanging:
- Freihängend:

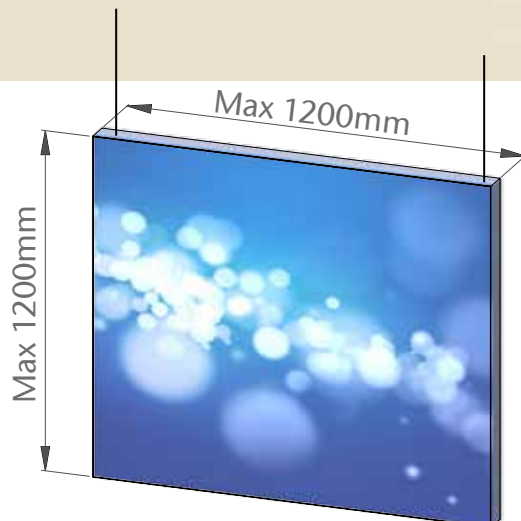

■ Gælder for: ■ Works with: ■ Gilt für:

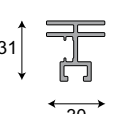
 31 30 <b>SF-44-8</b>
---

- Kuber og søjleinddækninger:
- Cubes and cladding for columns:
- Würfelbau und Stützenabdeckungen:

- Kube:
- Cube:
- Würfel:

- Hjørneprofil:
- Corner profile:
- Eckprofil:

SF-44-44-2



- Dobbeltsmig
- Double bevel
- Doppelschräg



- Connectorsamling
- Connector
- Schraubenverbindung



- Easy Lock samling
- Easy Lock joining
- Easy Lock Sammling

- Søjleinddækning:
- Cladding for columns:
- Stützenabdeckung:

- Hjørneprofil:
- Corner profile:
- Eckprofil:

SF-44-44-2

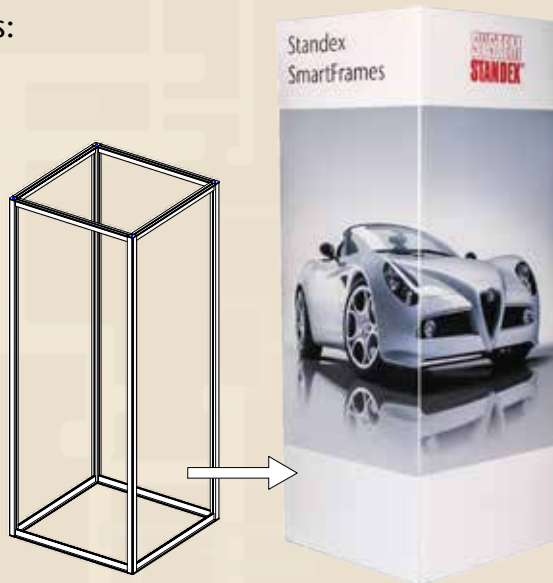

- Cylindre:
- Curves:
- Zylinder:

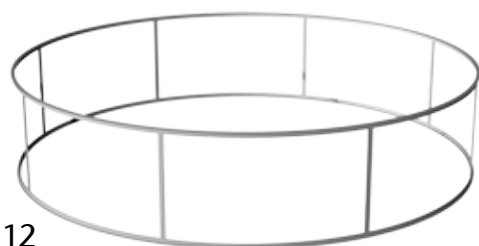

- Gælder for:
- Works with:
- Gilt für:

SF-36-2      SF-44-2



# Profiles for fabric graphics:

- Profiler til enkeltsidede rammer:
- Profiles for single sided frames:
- Profile für einseitige Rahmen:

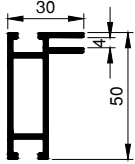

**SF-44-1**  
 ■ Til standardrammer  
 ■ Single sided frame  
 ■ Für Standardrahmen

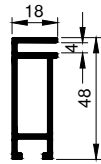

**SF-44-6**  
 ■ Til vægophæng  
 ■ For wall mounting  
 ■ Für Wandmontage

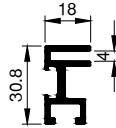

**SF-44-7**  
 ■ Til lette rammer  
 ■ For light frames  
 ■ Für leichte Rahmen

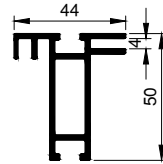

**SF-44-9**  
 ■ Mulighed for bagplade  
 ■ Takes a back panel  
 ■ Möglichkeit für Plattenrückwand

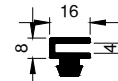

**1105-16**  
 ■ Til lette rammer  
 ■ For light frames  
 ■ Für leichte Rahmen

- Profiler til dobbeltsidede rammer:
- Profiles for double sided frames:
- Profile für beidseitige Rahmen:

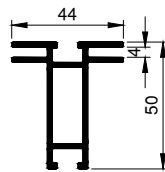

**SF-44-2**  
 ■ Til standardrammer  
 ■ Double sided frames  
 ■ Für Standardrahmen

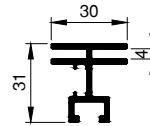

**SF-44-8**  
 ■ Til standardrammer  
 ■ Double sided frames  
 ■ Für Standardrahmen

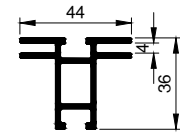

**SF-36-2**  
 ■ Til standardrammer  
 ■ Double sided frames  
 ■ Für Standardrahmen

- Profiler til enkeltsidede LED-rammer:
- Profiles for single sided LED frames:
- Profile für einseitige LED-Rahmen:

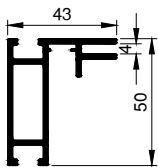

**SF-44-4**  
 ■ Til enkeltsidet montering af grafik  
 ■ For single sided graphics  
 ■ Für einseitige Grafik

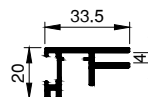

**SF-44-5**  
 ■ Til lette rammer med enkeltsidet montering af grafik  
 ■ For light frames with single sided graphics  
 ■ Für leichte Rahmen mit einseitige Grafik

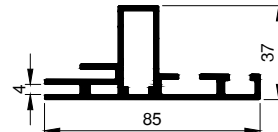

**SF-44-85**  
 ■ Til enkeltsidet montering af grafik samt bagplade  
 ■ For single sided graphics with back panel  
 ■ Für einseitige Grafik und Plattenrückwand

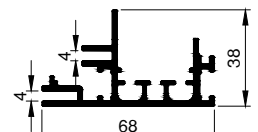

**SF-44-68**  
 ■ Til lyskasser på skinesystem  
 ■ For light boxes on rail systems  
 ■ Für Leuchtkästen Montiert auf Schienensysteme

- Profiler til dobbeltsidede LED-rammer:
- Profiles for double sided LED frames:
- Profile für beidseitige LED-Rahmen:

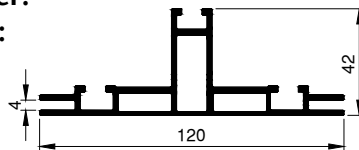

**SF-44-120**  
 ■ Til dobbeltsidet montering af grafik  
 ■ For double sided graphics  
 ■ Für beidseitige Grafik

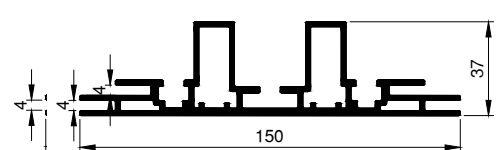

**SF-44-150**  
 ■ Til dobbeltsidet montering af grafik  
 ■ For double sided graphics  
 ■ Für beidseitige Grafik

- Søjleprofil:
- Upright profile:
- Stützenprofil:

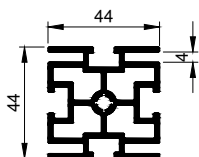

**SF-44-44-4**  
 ■ Til samling af rammer  
 ■ For connecting frames  
 ■ Für die Verbindung von Rahmen

- Hjørneprofil:
- Corner profile:
- Eckprofil:

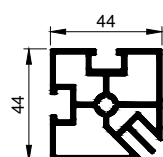

**SF-44-44-2**  
 ■ Til søjleinddækninger og kuber  
 ■ Cubes and cladding columns  
 ■ Für Stützenabdeckungen und Würfelbau

- Afslutningsprofil:
- Completion profile:
- Abschlußprofil:

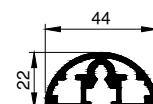

**SF-36-2R**  
 ■ Monteres med EasyLock greb  
 ■ Mounting with EasyLock handle  
 ■ Wird mit EasyLock Griffen montiert



- Samleled:
- Connectors:
- Verbinder:

Connector:

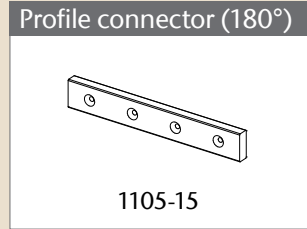
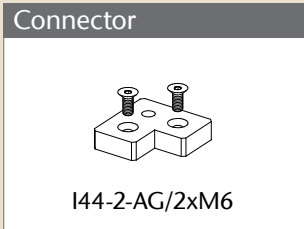

■ Gælder for: ■ Works with: ■ Gilt für:

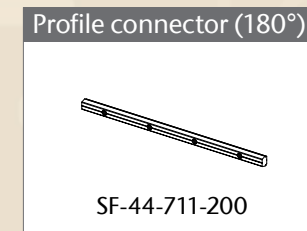
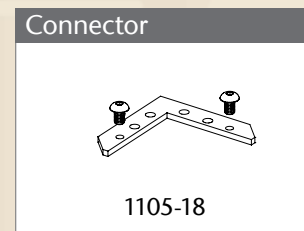
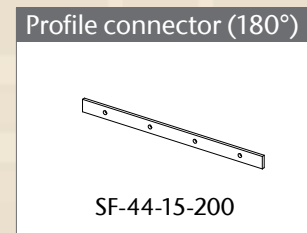
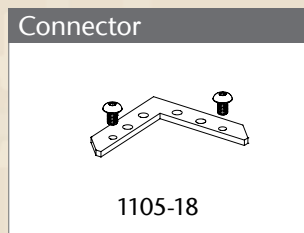
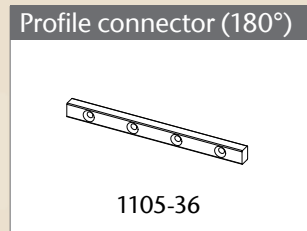
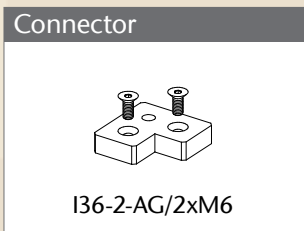
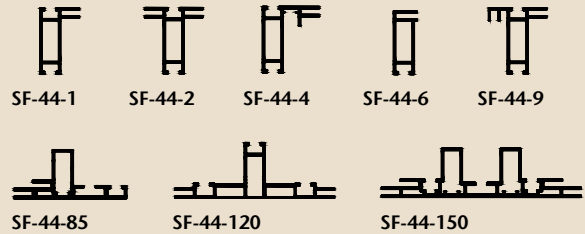

- Vægbeslag: ■ Wall brackets: ■ Wandbeschlag:

SF-44-3-15x40 Mounting:  
Fits to: SF-44-1,  
SF-44-4, SF-44-6 &  
SF-44-7

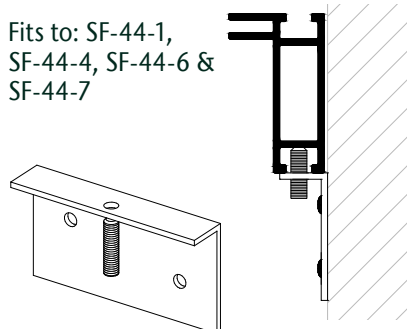

SF-44-3-8x40 Mounting:  
Fits to: SF-44-5

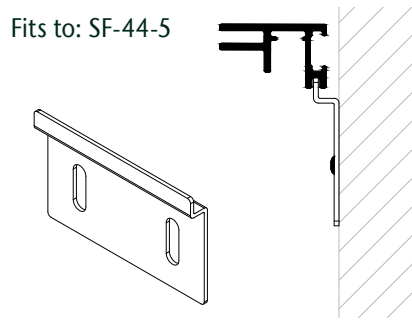

SF-44-4-30x60 Mounting:  
Fits to: SF-44-2 &  
SF-36-2

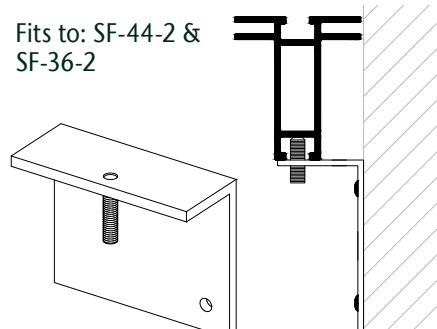

- Fodplader:
- Bases:
- Fußplatten:

### WSF-SFS

Passer til / Fits to / Geeignet für:  
SF-44-1, SF-44-2, SF-44-4, SF-44-9 & SF-36-2

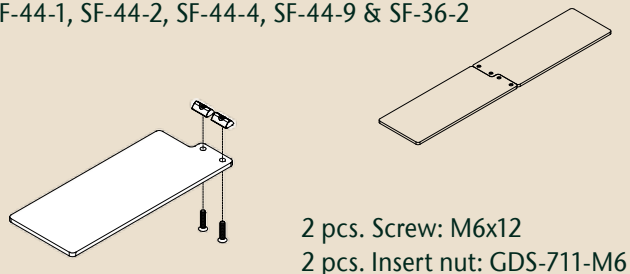

■ Montering: ■ Mounting: ■ Montierung:

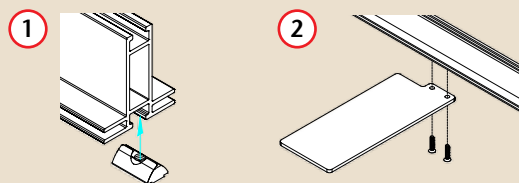

### WSF-SFS-2

Passer til / Fits to / Geeignet für:  
SF-44-1, SF-44-2, SF-44-4, SF-44-9, SF-36-2

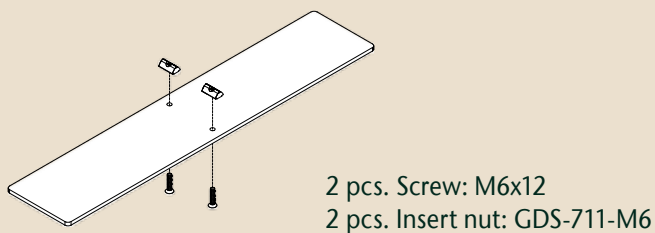

■ Montering: ■ Mounting: ■ Montierung:

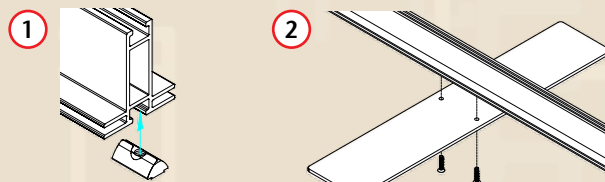

### WSF-SFS-3

Passer til / Fits to / Geeignet für:  
SF-44-85, SF-44-120

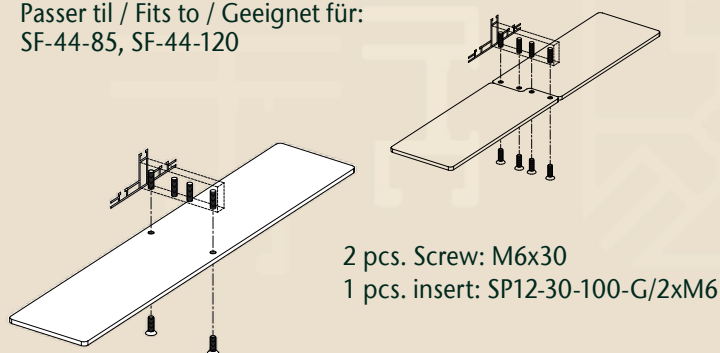

■ Montering: ■ Mounting: ■ Montierung:

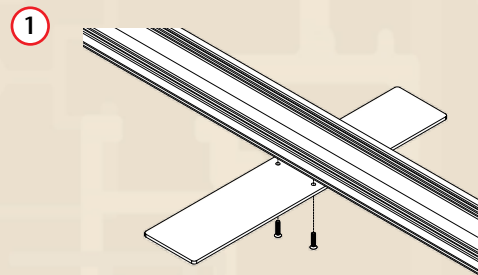

### WSF-SFS-4

Passer til / Fits to / Geeignet für:  
SF-44-150

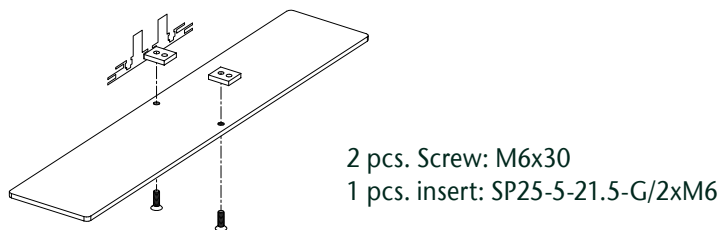

■ Montering: ■ Mounting: ■ Montierung:

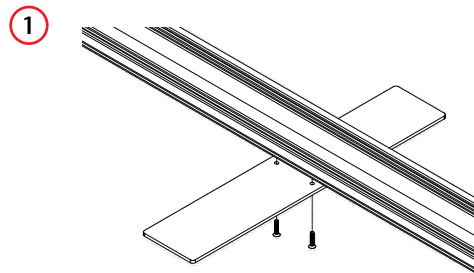

- ForstærkningsARGE til rammer:
- Internal supports for frames:
- Stützzarge für Rahmen:

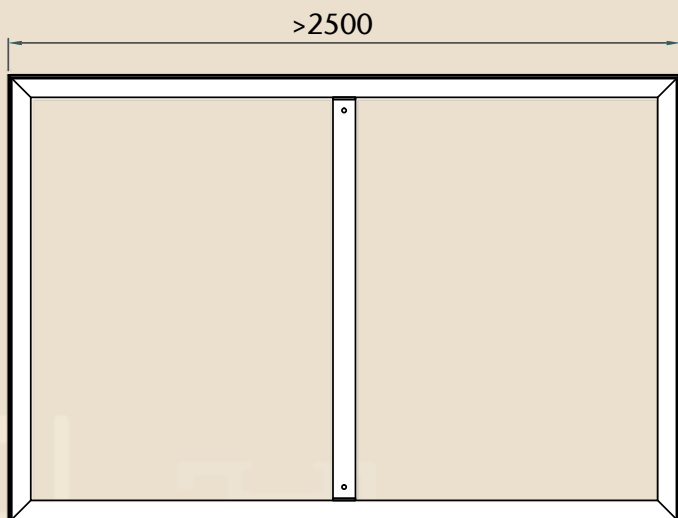

- Der indsættes en lodret forstærkningsarg ved ramme bredder over 2500mm og igen for hver 2500mm
- A support rail is added if the frame width exceeds 2500mm and again for each 2500mm
- Ein Stützzarge wird hinzugefügt wenn die Breite 2500mm übersteigt und wieder für je 2500mm



- Der indsættes vandrette forstærkningsarge ved ramme højder over 2500mm og igen for hver 2500mm
- A support rail is added if the frame height exceeds 2500mm and again for each 2500mm
- Ein Stützzarge wird hinzugefügt wenn die Höhe 2500mm übersteigt und wieder für je 2500mm

**WS-26-S**

- Profil til afstivning af store rammer af profil:
- Profile for supporting large frames:
- Versteifungsprofil für große Rahmen:

SF-44-1, SF-44-2, SF-44-4,  
SF-44-6, SF-44-7, SF-44-8,  
SF-44-9, SF-44-85, SF-44-120,  
SF-44-150, SF-44-44-2 &  
SF-44-44-4

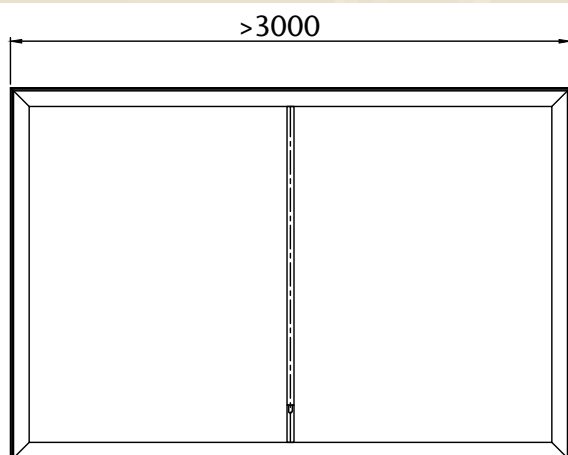

**WS-27-S**

- Profil til afstivning af store rammer af profil:
- Profile for supporting large frames:
- Versteifungsprofil für große Rahmen:

SF-44-150

- Rammer til udstillingsbrug med SF-HANDLE:
- Frames for exhibitions with SF-HANDLE:
- Rahmen für Ausstellungen mit SF-HANDLE:

■ SF-HANDLE gør rammerne til et udstillingssystem der er nemt at opstille uden brug af værktøj.

■ SF-HANDLE this makes the frame into an exhibition system with the turn of a handle. Easy to build, use and transport. No tools required.

■ SF-HANDLE umwandeln die Rahmen in ein Ausstellungssystem, das einfach ohne Werkzeug aufzustellen ist.

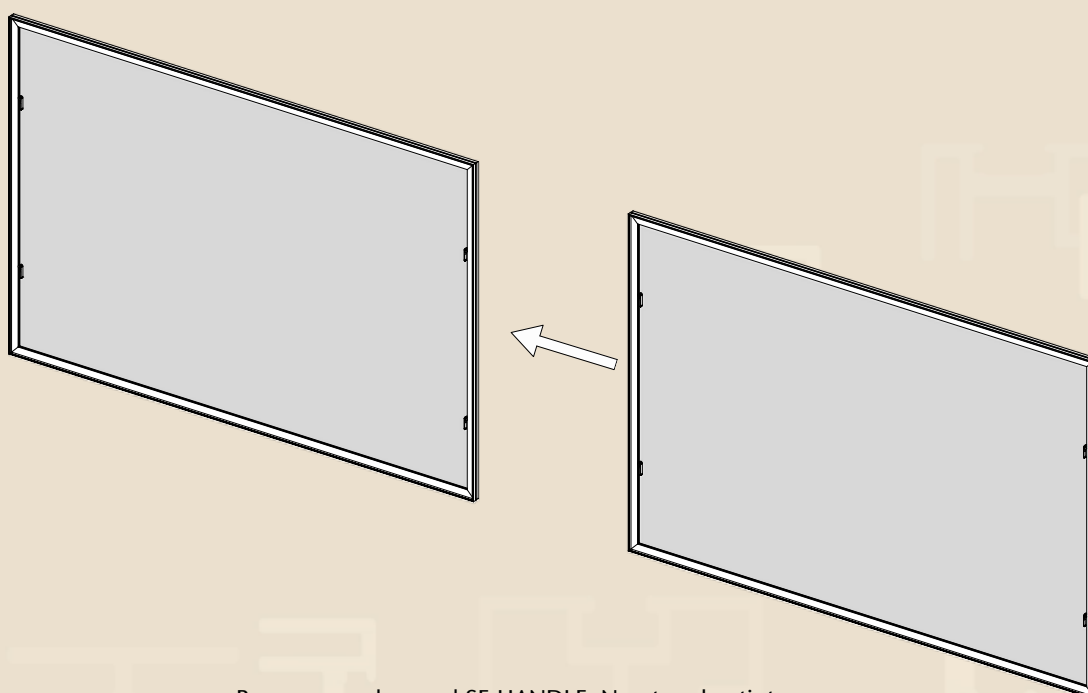

- Rammer samles med SF-HANDLE. Nemt og hurtigt.
- Frames joined together with SF-HANDLE. Easy and quick.
- Rahmen miteinander verbinden. Einfach und schnell.

**SF-HANDLE**

- SF-Handle lås
- SF-Handle
- SF-Handle Griff

for profile: SF-44-1, SF-44-2, SF-44-4, SF-44-9.



- Skub sammen
- Push together
- Zusammenschieben



- Drej
- Turn
- Drehen



- Lås
- Lock
- Verriegeln

- Rammer til udstillingsbrug med SF-HANDLE:
- Frames for exhibitions with SF-HANDLE:
- Rahmen für Ausstellungen mit SF-HANDLE:

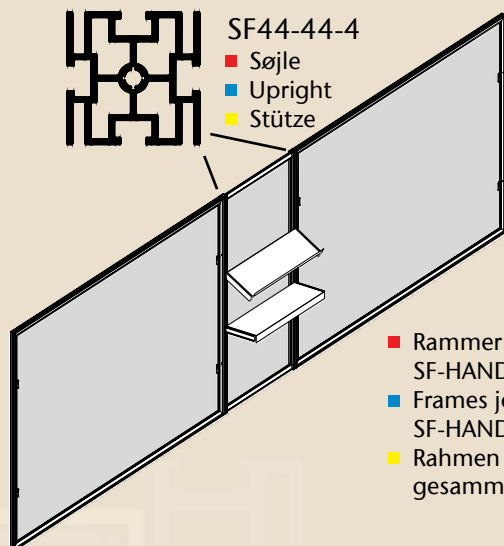

- Rammer koblet sammen med SF-HANDLE
- Frames joined together with SF-HANDLE
- Rahmen mit SF-HANDLE gesammelt

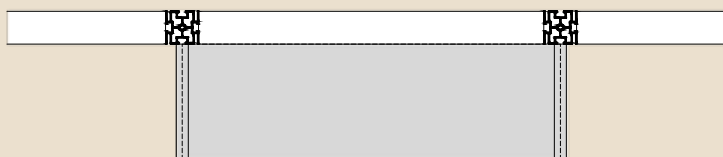

- Rammer samles til stande i forskellige vinkler med SF-HANDLE og søjler
- Frames joined together to form stands with SF-HANDLE and uprights
- Rahmen für Stände mit SF-HANDLE und Stützen zusammengebaut in unterschiedlichen Winkeln

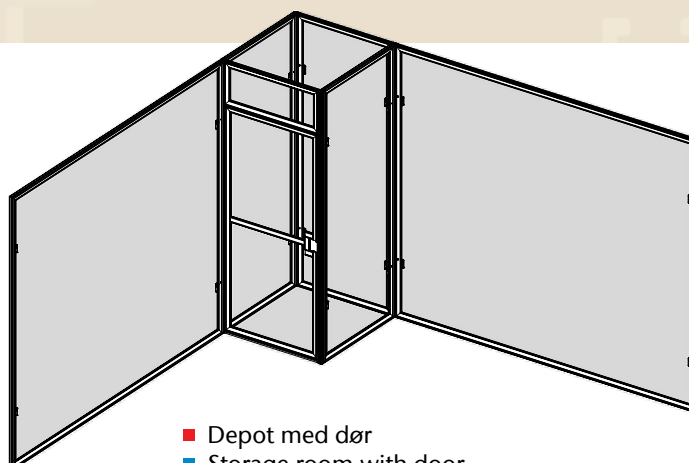
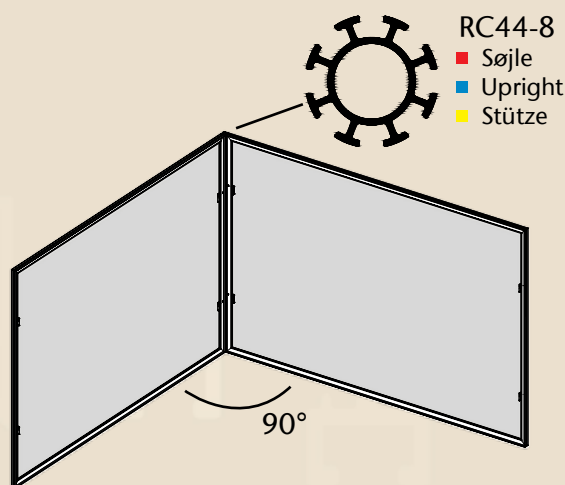
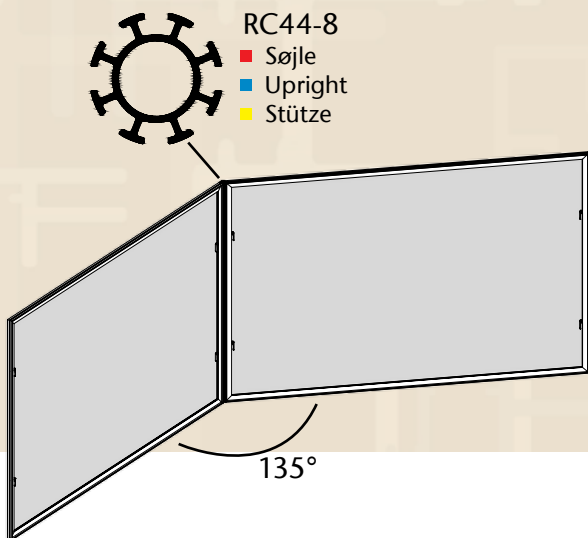

- Depot med dør
- Storage room with door
- Stauraum mit Tür



- Eksempler på udstillingsstande:
- Examples of exhibition stands:
- Beispiele von Ausstellungen:

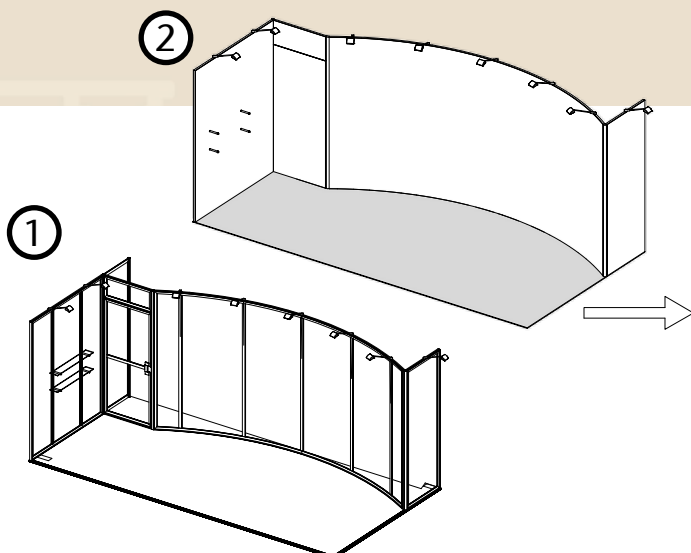
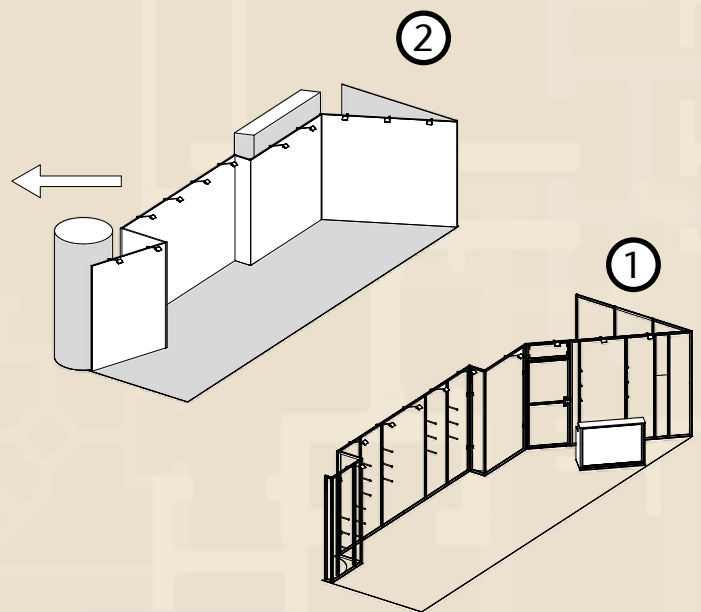
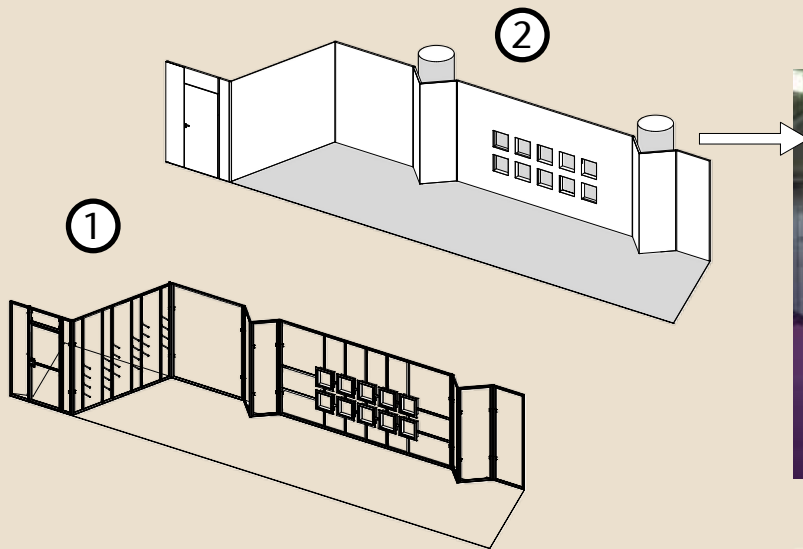

- Tilbehør til udstillingsrammer:
- Accessories for exhibition frames:
- Zubehör für Ausstellungsrahmen:

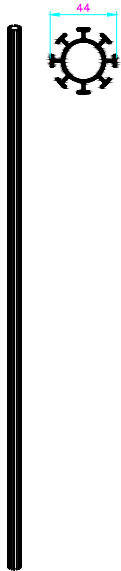

**RC44-8**

- Søjle
- Upright
- Stütze

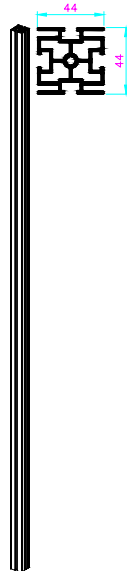

**SF-44-44-4**

- Søjle
- Upright
- Stütze

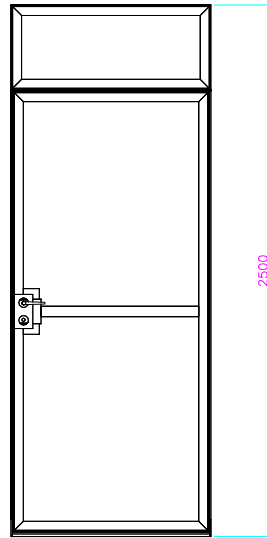

**SF-44-DOOR**

- Dør
- Door
- Tür

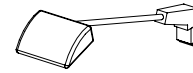

**GDS-HSP-120**

- 120w spotlight inkl. GDS-BRACKET
- 120w spotlight incl. GDS-BRACKET
- 120w Spotlight einschl. GDS-BRACKET

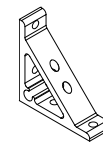

**M-150-22**

- Forstærkningshjørne til rammer af profil:
- A corner brace for frames of profile:
- Verstärkungsecke für Rahmen aus Profil:

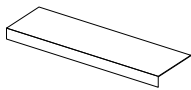

**1210**

- Hylde, hvid
- Shelf, white
- Regalboden, weiss



**1211**

- Hyldebærer
- Shelf support
- Regalträger

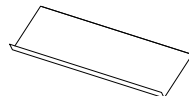

**1212**

- Skrå hylde, hvid
- Magazine shelf, white
- Prospektablage, weiss, geneigt



**1213**

- Skrå hyldebærer
- Shelf support
- Regalträger, geneigt



**1108-1**

- Søjleforlænger
- Upright extension
- Stützenverlängerung

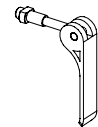

**SF-HANDLE**

- EasyLock lås
- EasyLock
- EasyLock Griff

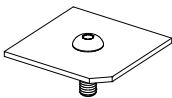

**SF-44-44-2-D6**

- Til afdækning af top og bund på profil:
- Endcap, top and bottom, for profile:
- Profilabdeckung, Top und Boden, für Profile:

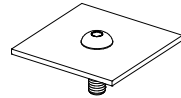

**SF-44-44-4-D6**

- Til afdækning af top og bund på profil:
- Endcap, top and bottom, for profile:
- Profilabdeckung, Top und Boden, für Profile:

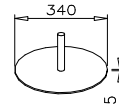

**WSF-44**

- Fodplade
- Base
- Fußplatte

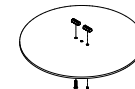

**WSF-FRAME**

- Fodplade
- Base
- Fußplatte

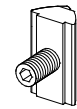

**EL-GUIDE**

- Styr
- Guide
- Führung



**1105-17**

- PVC-profil til montering af stofbanner
- PVC-profile for the fitting of fabrics
- PVC-Profil für Montage von Textilbanner



**1231-2-6x8**

- Øjeskrue for skydemøtrik:
- Eye bolt for sliding nuts
- Ösenskrube für Aufhängebeslag:



**1231-3**

- Øjeskrue for profil:
- Eye bolt for profile:
- Ösenskrube für Profile:



**GDS-711-M6**

- Indstiksmøtrik M6
- Insert nut M6
- Nutenstein M6, einsteckbar

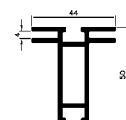

- For profiler se side 13
- For profiles see page 13
- Für Profile siehe Seite 13

- Supermagnetsystem:
- Super magnet system:
- Supermagnetsystem:

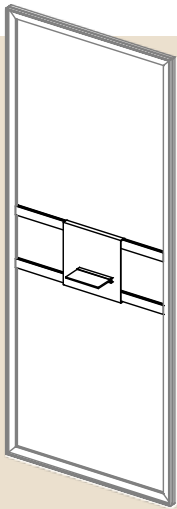
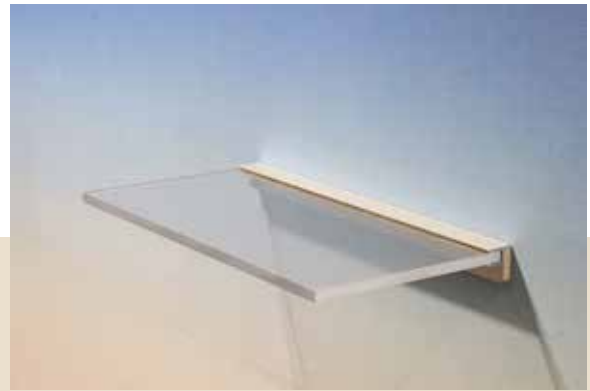

### Magnet panel

- Magnetplade til hylder og diverse
- Magnet panel mounted on rails
- Magnetplatte für Ablagen u. Ä.

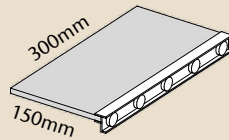

### SM-6

- Magnethylde med klar akryl
- Magnetic shelf with clear acrylic
- Magnet Regal mit klarem Akryl

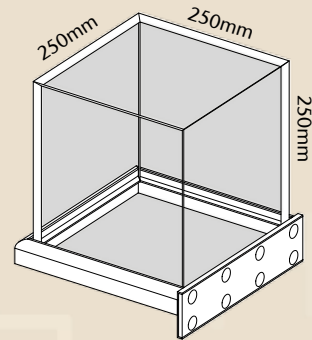

### SM-7

- Magnetvitrine med klar akryl
- Magnetic showcase with clear acrylic
- Magnetvitrine mit klarem Akryl

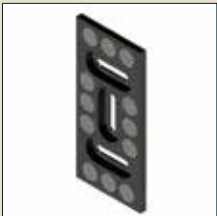

### SM-1 (12kg)

- Holder med magneter
- Holder with magnets
- Halterung mit Magneten

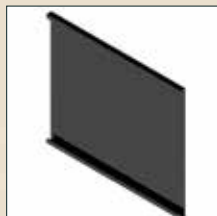

### SM-3

- Stålblade for magneter
- Steel back for magnets
- Stahlrückwand für Magneten



### SM-4

- Værktøj til afmontering af magnetholder
- Tool for removing of holder with magnets
- Werkzeug zum abnehmen der Halterung

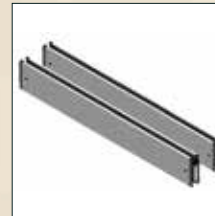

### 1201-S

- Sarg for stålplade
- Cross rails for steel back
- Zargen für Stahlrückwand



### SM-5

- Skrå bøjlestang, 35cm
- Angled hanger bar 35cm
- Schräge Biegelstange, 35cm

- Tilbehør til vægskinner:
- Accessories for rails:
- Zubehör für Schienen:

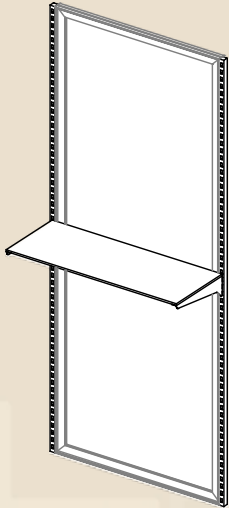
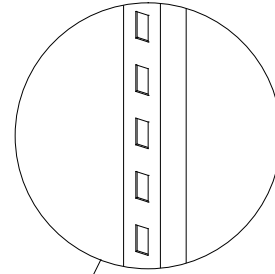

### Shelf

- Hylde monteret på skinner
- Shelf mounted on rails
- Regal auf Schienen montiert

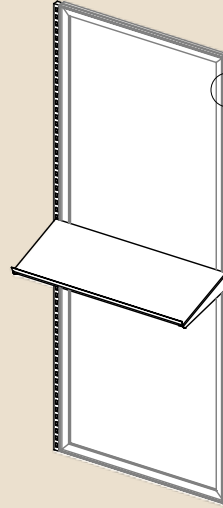

### Magazine shelf

- Skrå brochurehylde monteret på skinner
- Angled magazine shelf mounted on rails
- Schräge Prospektablage auf Schienen montiert

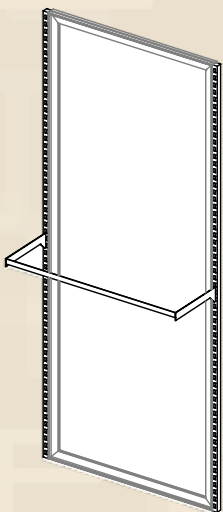

### Hanger bar

- Bøjlestang monteret på skinner
- Hanger bar mounted on rails
- Bügelstange auf Schienen montiert

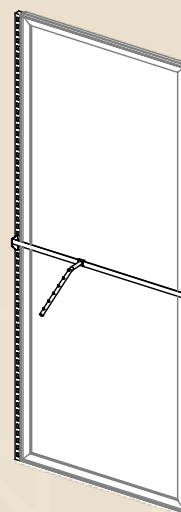

### Angled hanger bar

- Skrå bøjlestang monteret på skinner
- Angled hanger bar mounted on rails
- Schräge Bügelstange auf Schienen montiert

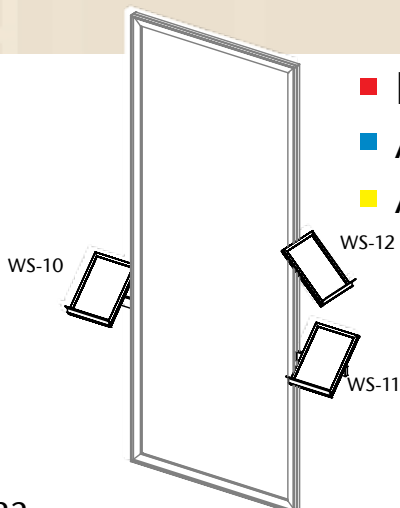

- Brochurebakke A4 format:
- A4 Leaflet shelf:
- A4 Prospektablagen:



### WS-10

- Brochurebakke 45° højre
- Leaflet shelf, 45° right
- Prospektablage, 45° rechts



### WS-11

- Brochurebakke 45° venstre
- Leaflet shelf, 45° left
- Prospektablage, 45° links



### WS-12

- Brochurebakke 45° midt
- Leaflet shelf, 45° centre
- Prospektablage, 45° mittig

- Lyskasseprofil til skinneresystemer:
- Light box profile and rail bracket:
- Leuchtkastenprofil für Schienensystem:

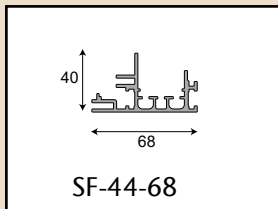

- Profil til lyskasser monteret på skinneresystemer i butikker og udstillinger. Lyskasserne laves på mål og kan tilpasses et eksisterende skinneresystem.
- Specially designed profile for light boxes that require fixing to a rail system. The light boxes are made to your size and specification allowing them to be used with all types of systems.
- Profil für Leuchtkästen auf Schienensystemen in Geschäften und Ausstellungen montiert. Die Leuchtkästen werden auf Maß angefertigt und können zu einem vorhandenen Schienensystem angepasst werden.

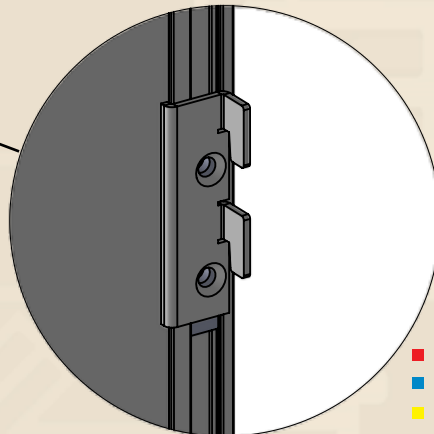
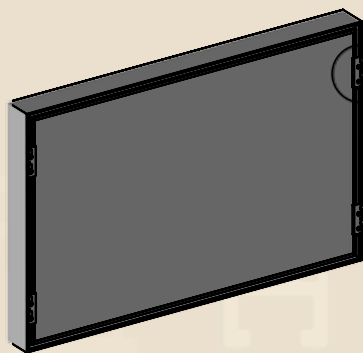
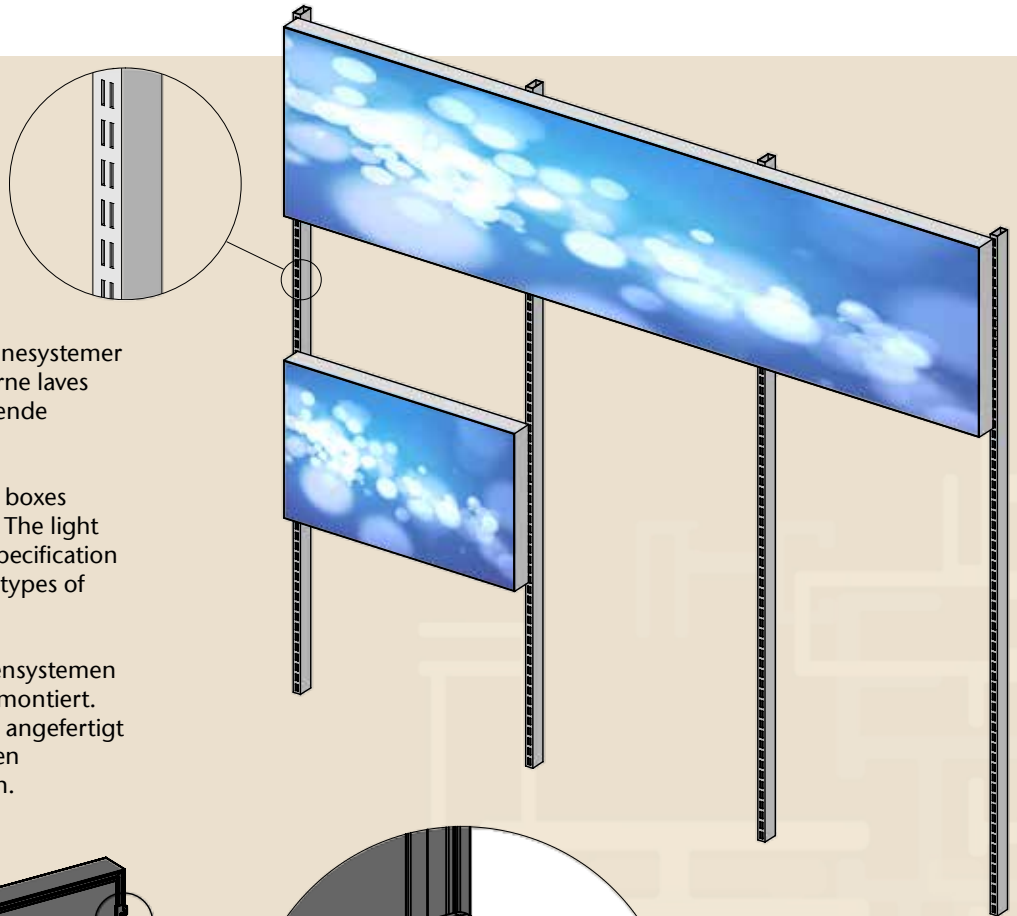

- Hægtebeslag til skinneresystem
- Bracket for rail system
- Hakenhalterung für Schienensystem

- Profil til indbygningslyskasser i vægniche:
- Profile for built-in light boxes
- Profil für Einbau LED Leuchtkästen

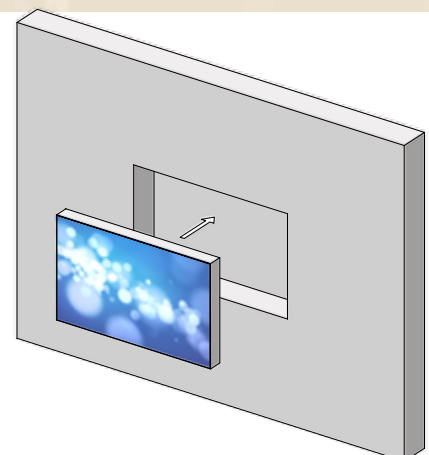
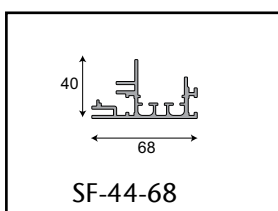



- TV ophæng og delvis LED belysning af rammen:
- TV screen supports and LED illuminating part of the frame:
- TV-Halterung und LED-Beleuchtung von einem Teil des Rahmens:

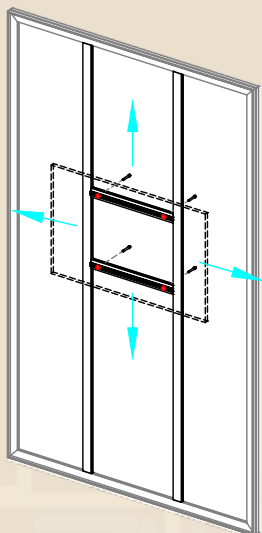

**TV & Flatscreen**

- Justerbar ophæng til fladskærm
- Adjustable supports for screen
- Einstellbare Beschläge für Bildschirme

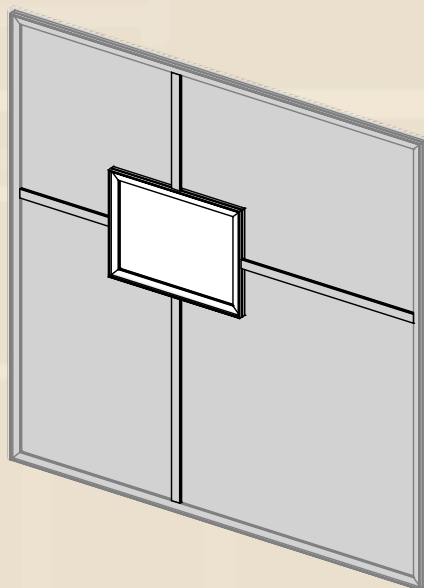

**LED illuminating of part of the frame**

- LED belysning af et udsnit af rammen
- LED illuminating of part of the frame
- LED-Beleuchtung von einem Teil des Rahmens

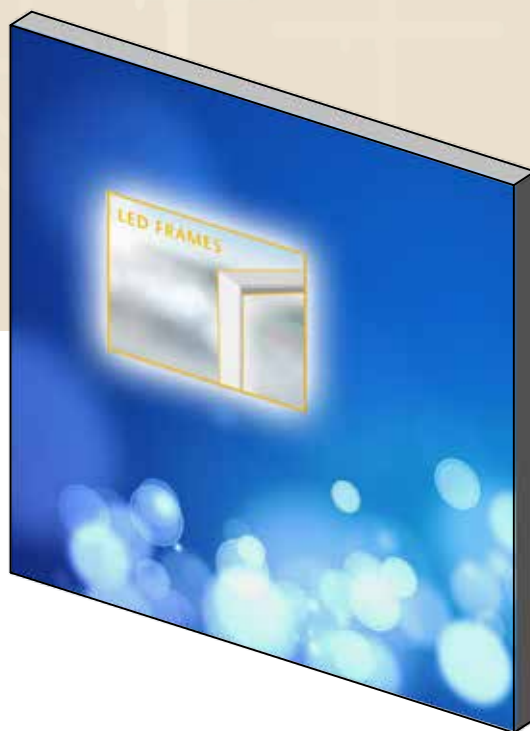

# Technical info:

- Ramme overflade
- Frame finish
- Rahmen Oberfläche



- **Standard overflade:**
- **Standard finish:**
- **Standard Oberfläche:**



- Sølvanodiseret
- Silver anodised
- Silberanodisiert

- **Alternative muligheder:**
- **Alternative options:**
- **Alternative Möglichkeiten:**



- Pulverlakering i RAL-farver
- Powder coat in RAL colours
- Pulverbeschichtung in RAL Farben

- Stoffbanner
- Fabric graphics
- Textilbanner

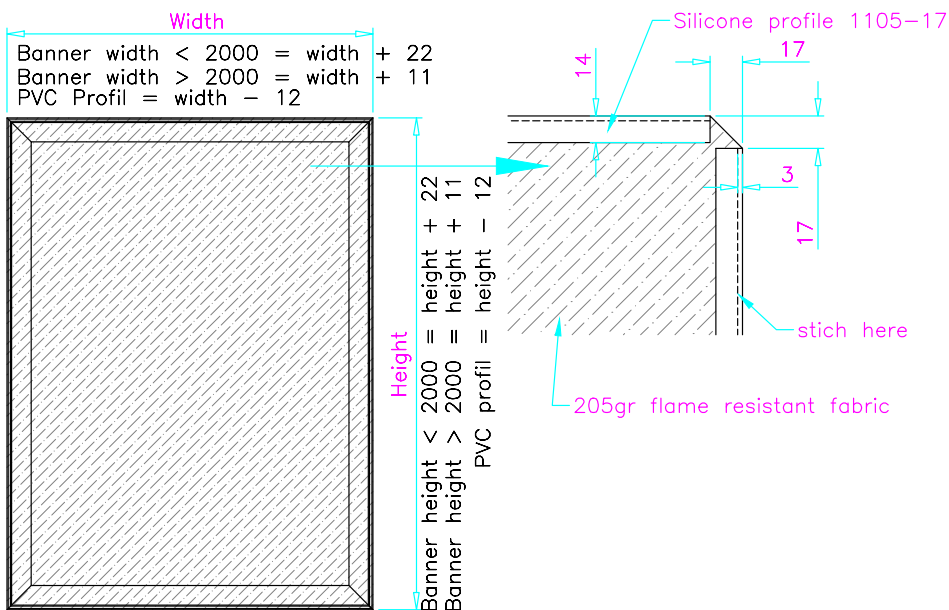

- Stoffbanner med påsyet PVC-liste for hurtig og nem montering
- Fabric graphics with sewn PVC profile for quick and easy installation
- Textilbanner mit aufgenähtes PVC-Profil für schnelle und einfache Montierung

- Stoffbanner
- Fabric graphics
- Textilbanner

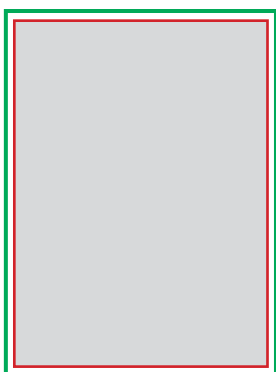

- **Grafikmål** = udvendigt mål på ramme
- **Graphic size** = outer dimension of the frame
- **Grafikmaß** = Außenmaße des Rahmens
- **Lysmål** = udvendigt rammemål minus 4mm
- **Actual visual size** = outer frame dimension of the frame minus 4mm
- **Sichtmaß** = Außenmaß des Rahmens minus 4mm

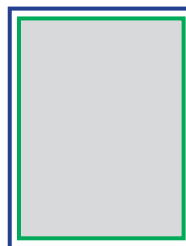

## Graphics file for print:

- **Bleed** = grafikmål plus 40mm i hver side
- **Bleed** = graphic size plus 40mm in each side
- **Beschnittzugabe** = Grafikmaß plus 40mm auf jede Seite
- PDF minimum 100 dpi 1:1
- Farver/colours/Farben: CMYK
- Skrifttyper vedlagt eller outlined
- Fonts attached or outlined
- Schriftarten beigelegt oder outlined

# EasyCase

- Transportkasser
- Transport cases
- Transportkisten

■ Hos System Standex laver vi EasyCase-transportkasser, der er specielt udviklet til Smartframes. Du kan få standardkasser til enkle standardløsninger, eller du kan få specielt tilpassede transportkasser, som passer bedst til dit behov.

Vores EasyCase-transportkasser kan monteres med hjul, så de kan håndteres uden truckhjælp, hvis bilen har hydraulisk bagsmæk eller der er læsserampe. Det sparer dyr truckleje og ventetid på udstillingsstedet.

■ System Standex offers EasyCase – transport cases designed to take SmartFrames. All cases are manufactured to specification.

EasyCase can be supplied with wheels or a pallet base to suit your preferred method of transport and handling.

■ System Standex stellt EasyCase-Transportkisten her, die speziell für Smart Frames ausgewickelt sind. Sie können Standard-Kisten für einfache Standardlösungen beziehen, oder Sie können Transportkisten bekommen, die Ihrer Bedürfnisse angepasst sind.

Unsere Easy Case-Transportboxen können mit Rädern ausgestattet werden, und Sie brauchen somit keinen Gabelstapler, wenn der LKW eine Laderampe hat. Sie sparen also die Kosten für das Mieten des teuren Gabelstaplers und Wartezeiten am Ausstellungsort.





- Fotogalleri:
- Photo gallery:
- Foto-Galerie:



- Vægmonteret i butik
- Wall mounted in shop
- Wandmontiert in der Laden



- Opbygning af udstillingsstande
- Building of exhibition stands
- Bau von Ausstellungsständen



- Dekoration i showroom
- Decoration in the showroom
- Dekoration im Ausstellungsraum



- Profilerne kan vales til runde former efter opgave
- Profiles can be rolled for round frames
- Profile können zu runden Rahmen gerollt werden

## Fritstående LED rammer



- Fritstående i butik
- Free standing in shop
- Freistehend in der Laden



- Dobbeltsidet på udstilling
- Double sided on exhibition
- Beidseitig auf der Ausstellung



- Fritstående i showroom
- Free standing in showroom
- Freistehend in der Ausstellung



- Udstillingsstande
- Exhibition stands
- Ausstellungen



- Udstillingsstande
- Exhibition stands
- Ausstellungen



- Fritstående LED ramme
- Free standing LED light box
- Freistehender LED leuchtkasten



- Vægmonteret i kontor -akustik forbedring
- Wall mounted in office -improved acoustics
- Wandmontiert in Büro -schalldämpfend



- Showroom
- Showroom
- Showroom



- I kontorer -lydabsorberende
- In offices for noise reduction
- In Büros -schalldämpfend





- Dobbelsidet ramme
- Double sided frame
- Beidseitiger Rahmen





For information on:

## EASYLOCK SYSTEMS

**EASYLOCK-1**  
**EASYLOCK-2**  
**EASYLOCK-3**



**EASYLOCK-1**  
 Modular system for large fabric prints



**EASYLOCK-2**  
 Modular Fabric Print

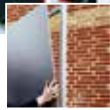

**EASYLOCK-3**  
 Modular Magnetic Panels

**SYSTEM  
 STANDEX®**

## STANDEX SKILTESYSTEMER



**SYSTEM  
 STANDEX®**

- EASYLOCK er velegnet til opbygning af messestande, salgsfremmende displays eller grafiske vægge, og kan anvendes på udstillinger, i butikker eller i showrooms. Systemet er stærkt og kan anvendes et utal af gange - det er fleksibelt og giver masser af muligheder for forskellige opbygninger. Kontakt os for mere information.
- EASYLOCK is designed for exhibition stands – promotional displays – graphic walls – visual merchandising – retail displays. EASYLOCK is a strong interchangeable system that can be used many times and in many different formats. Contact us for more information.
- EASYLOCK ist für den Bau von Messeständen, Werbedisplays oder als Grafikwand geeignet und kann bei Ausstellungen, im Ausstellungsraum oder Läden verwendet werden. Das System ist stark und kann beliebig oft verwendet werden - es ist flexibel und bietet viele verschiedene Möglichkeiten der Aufstellung. Kontaktieren Sie uns für weitere Information.

- Standex skiltesystem består bl.a. af snaprammer og rammer til stofprint med eller uden LED. Kontakt os for mere information.
- The Standex sign systems offers a wide range snap frames and fabric frames that are available with or without LED illumination. Contact us for more information.
- Standex Schildsysteme umfassen unter anderem Wechselrahmen und Rahmen für Stoffdruck mit oder ohne LED. Kontaktieren Sie uns für weitere Information.



- Hos System Standex er vi specialister i udvikling og produktion af løsninger med alu-konstruktioner. Løsningerne er baseret på vores egne profiler og samlemetoder, som giver nærmest uendelige muligheder for individuel udformning. Vi har egen produktion, overfladebehandling og montagefabrik. Det sikrer dig den største fleksibilitet i udformning og levering. Kontakt os om din opgave.
  
- At System Standex we are continually developing, producing and stocking a wide range of aluminium construction systems. Working closely with our customers these systems are used to manufacture products to their design. Our factory offers a comprehensive in house manufacturing and powder coating service. Please contact us for further information or a quotation.
  
- Bei System Standex haben wir uns in der Auswicklung und Herstellung von Lösungen mit Aluminium Konstruktionssysteme spezialisiert. Die Lösungen basieren auf unsere eigene Profile und Sammelmethode, und wir erzielen so durch fast unendliche Möglichkeiten von individuellen Designs. Wir verfügen über eigene Produktion, Oberflächenbehandlung und Montagefabrik, und sichern somit die beste Flexibilität Ihres Entwurfs sowie Lieferung. Kontakt Sie uns bei der nächsten Aufgabe.

Please contact us at:

SYSTEM STANDEX A/S

Herluf Trolles Vej 140 - DK-5220 Odense SØ

Tel.: +45 66 15 66 15 Fax.: +45 66 15 55 48

info@system-standex.dk - www.system-standex.dk



**SYSTEM**  
**STANDEX®**