

EASYLOCK-3

Modular Magnetic Panels



- EASYLOCK rammer
- EASYLOCK frames
- EASYLOCK Rahmen

- Enkel montering af grafik
- Easy mount graphics
- Simples monterien der Grafik

**SYSTEM
STANDEX®**

EASYLOCK-3

Modular magnetic panels

- Systemet består af 3 rammer i mål 1000 x 1000, 1000 x 500, og 500 x 500mm. Rammerne samles med det smarte EASYLOCK handle - uden brug af værktøj. Systemet er fremstillet til montering af plader i modulært format enkelt- eller dobbeltsidet alt efter behov.
- The systems consists of three pre assembled frames -1000 x 1000 – 1000 x 500 – 500 x 500mm. The frames lock together with the EASYLOCK handle – no tools required. The system is designed to take modular graphics – single or double sided.
- Die Systemrahmen sind in den Maßen 1000x1000, 1000x500, 500x500mm erhältlich. Die Rahmen sind mit dem smarten EASYLOCK handle montiert und werden ohne Werkzeug miteinander verbunden. Das System ist für die Montage von Platten in modularen Maßen aufgebaut, ein- oder beidseitig je nach Bedarf.

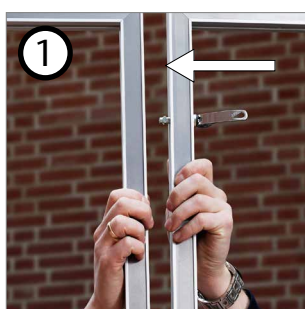

- Skub sammen
- Push together
- Zusammenschieben



- Drej
- Turn
- Drehen



- Lås
- Lock
- Verriegeln

EASYLOCK-3

Modular magnetic panels

- Pladerne monteres med magnetbånd. Rammerne har stålband monteret på begge sider. F.eks. en væg bestående af 12 rammer i 1000 x 1000mm og 12 stk. plader i 1000 x 1000mm. Af tilbehør kan nævnes belysning, sidehængt dør, fodbeslag for fritstående væg eller display mm.
- The graphic panels requires magnetic tape (on the reverse) to fix to the steel strip in the framework. For example a wall constructed from 12 frames at 1000 x 1000mm would take 12 graphic panels at 1000 x 1000mm. Accessories include; lights – side hinged door – base plates – wall plates – bespoke items.
- Die Platten werden auf der Rückseite mit einem Magnetstreifen bestückt. Die Rahmen sind beidseitig mit Stahlbändern ab Werk vorbereitet. Beispiel: Eine Wand besteht aus 12 Rahmen 1000x1000mm und 12 Platten 1000x1000mm. Als Zubehör gehören Beleuchtung, eine Tür mit Seitenanschlag, Fußbeschläge für freistehende Wände oder Displays.



- EASYLOCK-1 er velegnet til opbygning af messestande, salgsfremmende displays eller grafiske vægge, og kan anvendes på udstillinger, events, i butikker eller i showrooms. Rammerne er fremstillet i aluminium og leveres samlet og klar til brug. Systemet er stærkt og kan anvendes et utal af gange - det er fleksibelt og giver masser af muligheder for forskellige opbygninger.
- EASYLOCK-3 is designed for exhibition stands – promotional displays – graphic walls – visual merchandising – retail displays. The frames are delivered assembled and ready to use. EASYLOCK-3 is a strong interchangeable system that can be used many times and in many different formats.
- EASYLOCK-3 ist für den Bau von Messeständen, Werbedisplays oder für Grafikwände geeignet, und kann bei Ausstellungen, Events, im Ausstellungsraum oder Läden verwendet werden. Die Rahmen sind aus Aluminium gefertigt und kommen fertig zusammengebaut und einsatzbereit an. Das System ist stark und kann beliebig oft verwendet werden - es ist flexibel und bietet viele verschiedene Möglichkeiten der Aufstellung.

EL-FRAME-MAG

1x1m, 1X0.5m & 0.5x0.5m

EL-FRAME-MAG-F

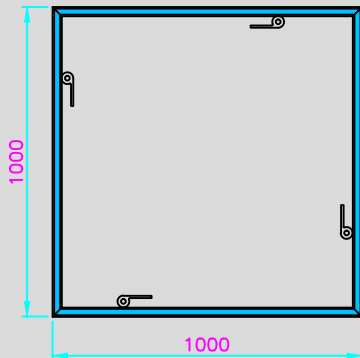

EL-FRAME-MAG-H

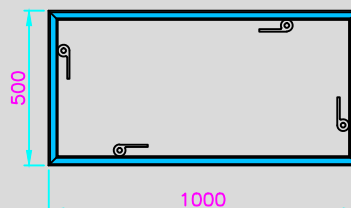

EL-FRAME-MAG-Q

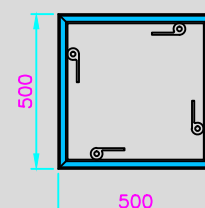

EL-FRAME-MAG-F-B

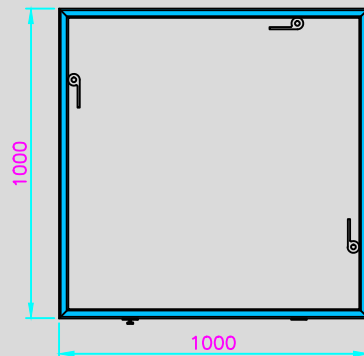

- Bundramme med MAGNET-FOOT-1 og MAGNET-FOOT-2
- Bottom frame with MAGNET-FOOT-1 and MAGNET-FOOT-2
- Bodenrahmen mit MAGNET-FOOT-1 und MAGNET-FOOT-2

- = Aluminiumprofil med stålband for grafik med påmonterede magnetbånd
- = Aluminium profile with steel strips for graphics with magnet tape
- = Aluminiumprofil mit Stahlbändern für Grafiken mit Magnetbändern

MAGNET-FOOT

- Pladestyr
- Panel guide
- Paneelführung



- På alle bundrammer monteres en MAGNET-FOOT-1 og en MAGNET-FOOT-2 til at styre pladerne på plads.
- On all lower frames fit a MAGNET-FOOT-1 and a MAGNET-FOOT-2 to help guide the frames into place.
- Unter alle Bodenrahmen, wird ein MAGNET-FOOT-1 Fuß und eine MAGNET-FOOT-2 Paneelführung montiert.

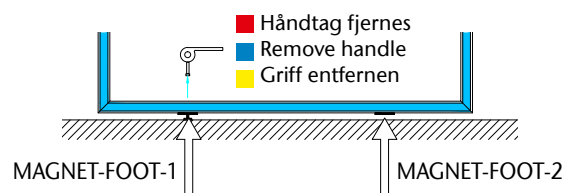

■ Tilbehør
■ Accessories
■ Zubehör

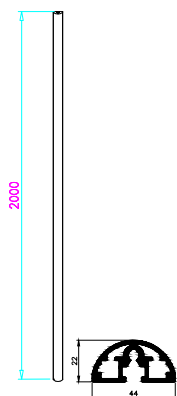

SF36-2R-2000

- Søjle 2000mm
- Upright 2000mm
- Stütze 2000mm

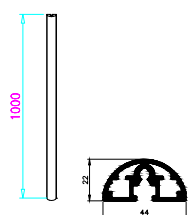

SF36-2R-1000

- Søjle 1000mm
- Upright 1000mm
- Stütze 1000mm

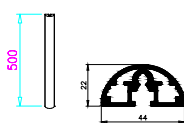

SF36-2R-500

- Søjle 500mm
- Upright 500mm
- Stütze 500mm

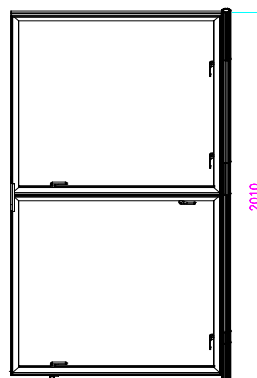

EL-DOOR-3

- Dør inkl. søjle
- Door incl. upright
- Tür mit Stütze

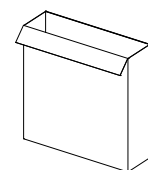

EL-TRANSPORT

- Transport
- Transport
- Transport



RC44-8-2010

- Søjle 2010mm
- Upright 2010mm
- Stütze 2010mm



RC44-8-1010

- Søjle 1010mm
- Upright 1010mm
- Stütze 1010mm

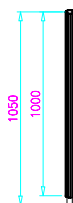

RC44-8-1000-D

- Søjle 1000mm
- Upright 1000mm
- Stütze 1000mm

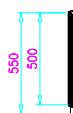

RC44-8-500-D

- Søjle 500mm
- Upright 500mm
- Stütze 500mm

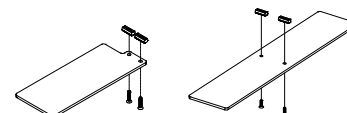

WSF-SFS

- Fod
- Foot
- Fuß

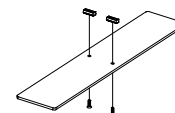

WSF-SFS-2

- Fod
- Foot
- Fuß

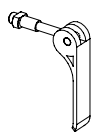

GDS-HANDLE

- EasyLock lås
- EasyLock
- EasyLock Griff

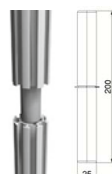

1108-1

- Søjleforlænger
- Upright extension
- Stützenverlängerung

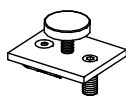

MAGNET-FOOT-1

- Stillefod
- Adjustable foot
- Stellfuss



MAGNET-FOOT-2

- Støtte
- Support
- Stütze



EL-HSP-LED

- LED spotlight
- LED spotlight
- LED Spotlight

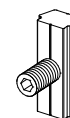

EL-GUIDE

- Styr
- Guide
- Führung

For information on:

EASYLOCK-1

Modular system for large fabric prints



■ EASYLOCK rammer
■ EASYLOCK frames
■ EASYLOCK Rahmen

■ Enkel monteret af grafik
■ Easy mount graphics
■ Simples monitieren der Grafik

**SYSTEM
STANDEX®**

EASYLOCK-2

Modular Fabric Print



■ EASYLOCK rammer
■ EASYLOCK frames
■ EASYLOCK Rahmen

■ Enkel monteret af grafik
■ Easy mount graphics
■ Simples monitieren der Grafik

**SYSTEM
STANDEX®**

Please contact us now at:

SYSTEM STANDEX A/S

Herluf Trolles Vej 140 - DK-5220 Odense SØ

Phone.: +45 66 15 66 15 Fax.: +45 66 15 55 48

info@system-standex.dk - www.system-standex.dk



**SYSTEM
STANDEX®**