

# STANDEX CUSTOM ENCLOSURES

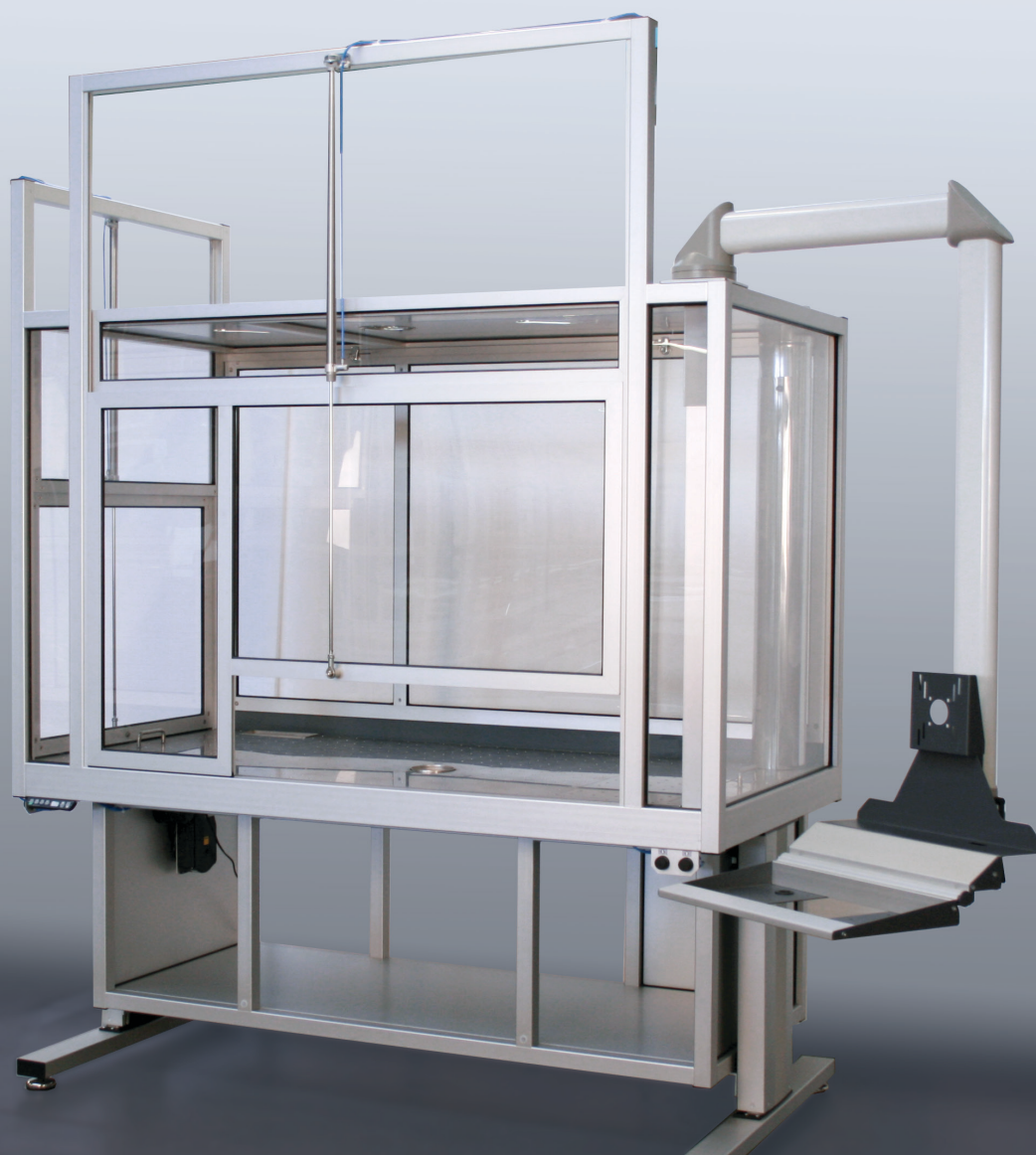

Nemt at rengøre



Ergonomisk



Sikkerhed

– kundetilpassede kabinetter

**SYSTEM**  
**STANDEX®**

# STANDEX ENCLOSURES

■ Standex sugeskabe kan fremstilles på mål nøjagtigt efter ønske. Adgang til sugeskabet kan designes med mange forskellige lågetyper bl.a hejselåger, aftagelige låger, sidehængte låger eller knæklåger. Stellet er lavet i solide anodiserede aluminium profiler med lukkede spor for optimal rengøring. Sugeskabene kan desuden udformes med effektiv støjreduktion til forbedring af arbejdsmiljøet. Understellet kan monteres med hæve-/sænkesøjler for ergonomisk korrekt indstilling af arbejdshøjden.

■ Standex suction cabinets can be produced exactly to meet the customers demands. Access to the enclosures can be designed with many different door types, in particular lifting doors, removable doors, hinged doors or folding doors. The frame is made of solid anodized aluminum profiles with closed surfaces for optimal cleaning. The enclosures can be designed with effective noise reduction to improve the working environment. The support table can be mounted with height adjustable columns for ergonomically correct working height.



■ Sugeskab med hejselåger og hæve-/sænkebord

■ Enclosure with vertical sliding door and height adjustable table



■ Sugeskab med lyddæmpning

■ Enclosure with sound insulation

# ENCLOSURE FEATURES

- • Stel i anodiserede aluminium profiler
- Klare plader i loft og sider. F.eks polycarbonat, hærdet glas eller lamineret glas.
- Mange lågemuligheder bl.a. sidehængte låger, hejselåger, aftagelige låger, knæklåger, eller skydelåger.
- Arbejdsplade i laminat eller rustfri stål med mulighed for kabelgennemføring, vask, sug mm.
- Mulighed for lyddæmpning med lydabsorberende plader og lyddæmpende glas.



- • Frame in anodized aluminum profiles.
- Clear panels in the roof and sides. E.g. polycarbonate, tempered glass or laminated glass.
- Many door options including sidehinged doors, vertically sliding doors, removable doors, side hinged bi-folding doors or sliding doors.
- Worktop in laminate or stainless steel with the option of cable ports, sink, suction.
- Optionally sound proofing with sound-absorbing panels and sound insulating glass.

## ■ Rulle vogne

Vogne fremstillet i aluminiums profiler, med f.eks. rustfri hylder. Vognene kan monteres med hæve/sænke søjler og kan tilpasses i størrelse og design efter ønske.

## ■ Trolleys

Trolleys manufactured in aluminium profiles with e.g. stainless shelves. Trolleys can be made with height-adjustable uprights and can be produced in size and design to specifications.



## DOOR SOLUTIONS

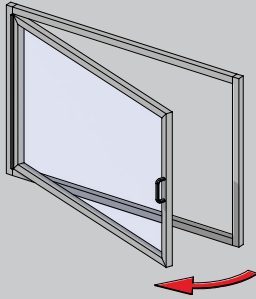

■ Sidehængt låge  
■ Side hinged door

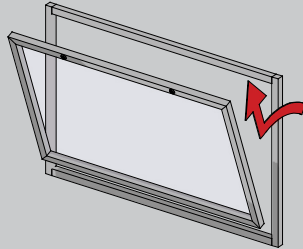

Bundstiftet låge  
Lift out access door

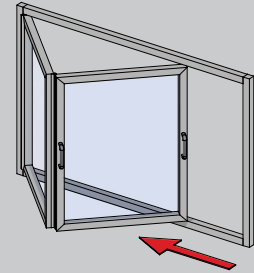

Knæklåge  
Sidehinged - bi folding

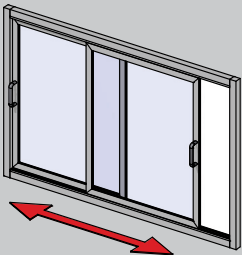

■ Skydelåge  
■ Sliding door

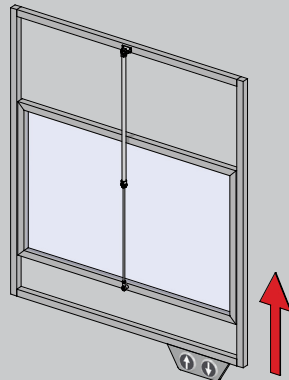

Hejselåge, pneumatisk  
Vertical sliding door - pneumatic

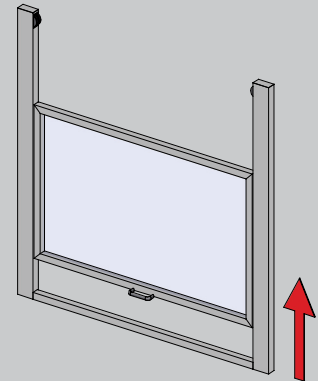

Hejselåge med skjult lod  
Vertical sliding door with concealed counter balance

## WORKTOPS

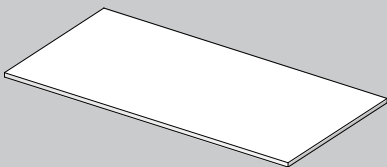

■ Laminat bordplade  
■ Laminate worktop

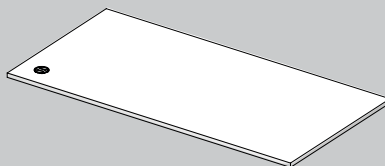

Kabelgennemføring  
Cable port

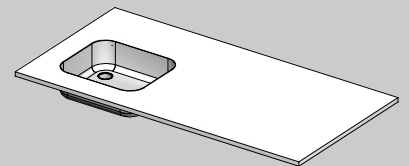

Rustfri vask med afløb  
Stainless steel sink with drain

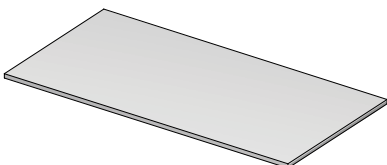

■ Rustfri bordplade  
■ Stainless steel worktop

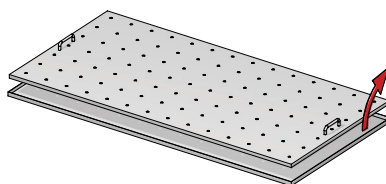

Aftagelig rustfri bordplade med bundkar  
Removable stainless steel worktop with sump tank

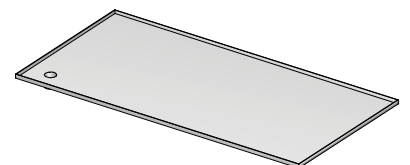

Rustfri kar med afløb  
Stainless steel sump tank with outlet drain

## SUPPORT TABLE

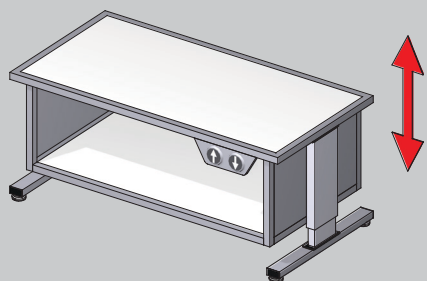

- Hæve-/sænkebord
- Height adjustable workstation

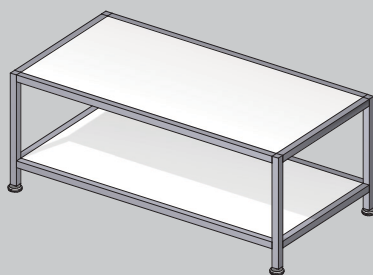

- Bord med stillefod
- Workstation with adjustable feet

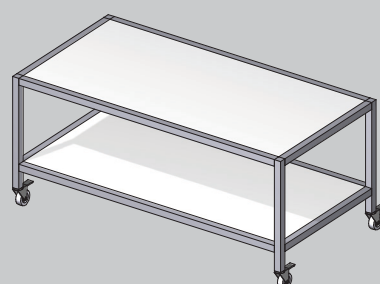

- Bord med hjul
- Workstation with wheels

## SOUND INSULATION

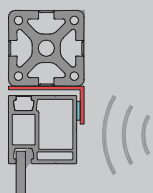

- Tætningsprofiler
- Sealing profiles

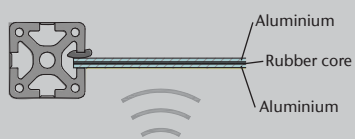

- Lyddæmpende sandwich plader
- Sound absorbing sandwich panels

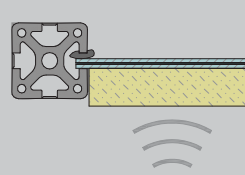

- Lyddæmpende isolering
- Sound absorbing insulation

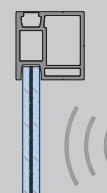

- Lyddæmpende glas
- Sound insulating glass



- Tætning omkring låger er den vigtigste faktor ved reduktion af støj. Hvis der skal dæmpes yderligere kan der anvendes lyddæmpende plader og lyddæmpende glas.
- A tight seal around the doors is the most important aspect of reducing noise. Higher reduction can be achieved with sound absorbing panels and sound insulating glass.

## PANEL OPTIONS

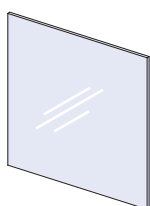

- Polycarbonat
- Polycarbonate

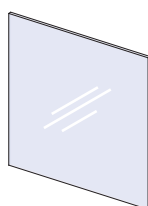

- Glas
- Glass

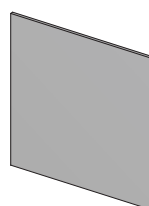

- Anodiseret aluminium
- Anodized aluminium

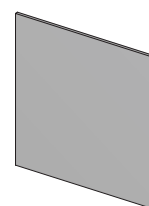

- Stål plade - pulverlakeret
- Steel plate - powder coated

## AIRFLOW

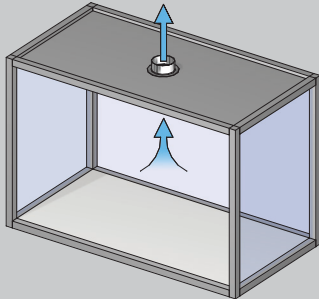

- Sugestuds monteret i loft
- Suction mounted in ceiling

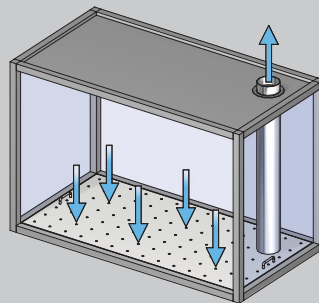

- Sug i bordpladen
- Suction in the worktop

## ALUMINIUM PROFILES

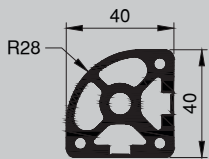

RC40-2R-C

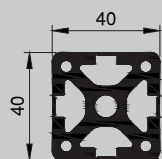

RC40-4-C

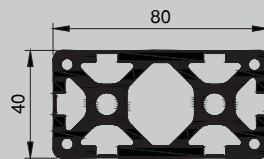

RC40-80-6-C

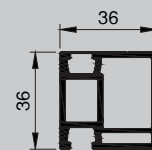

RC36-6-C



- En special profilendeplyade kan monteres for nemmere rengøring.

- A special profile cover can be used for easier cleaning.



- Hjul eller stillefod
- Wheels or feet

# STANDEX ENCLOSURE EXAMPLES

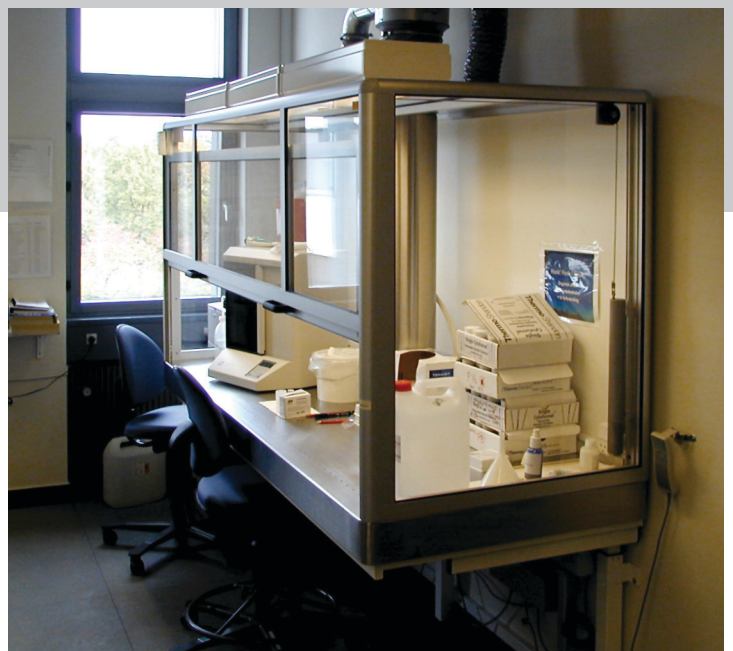

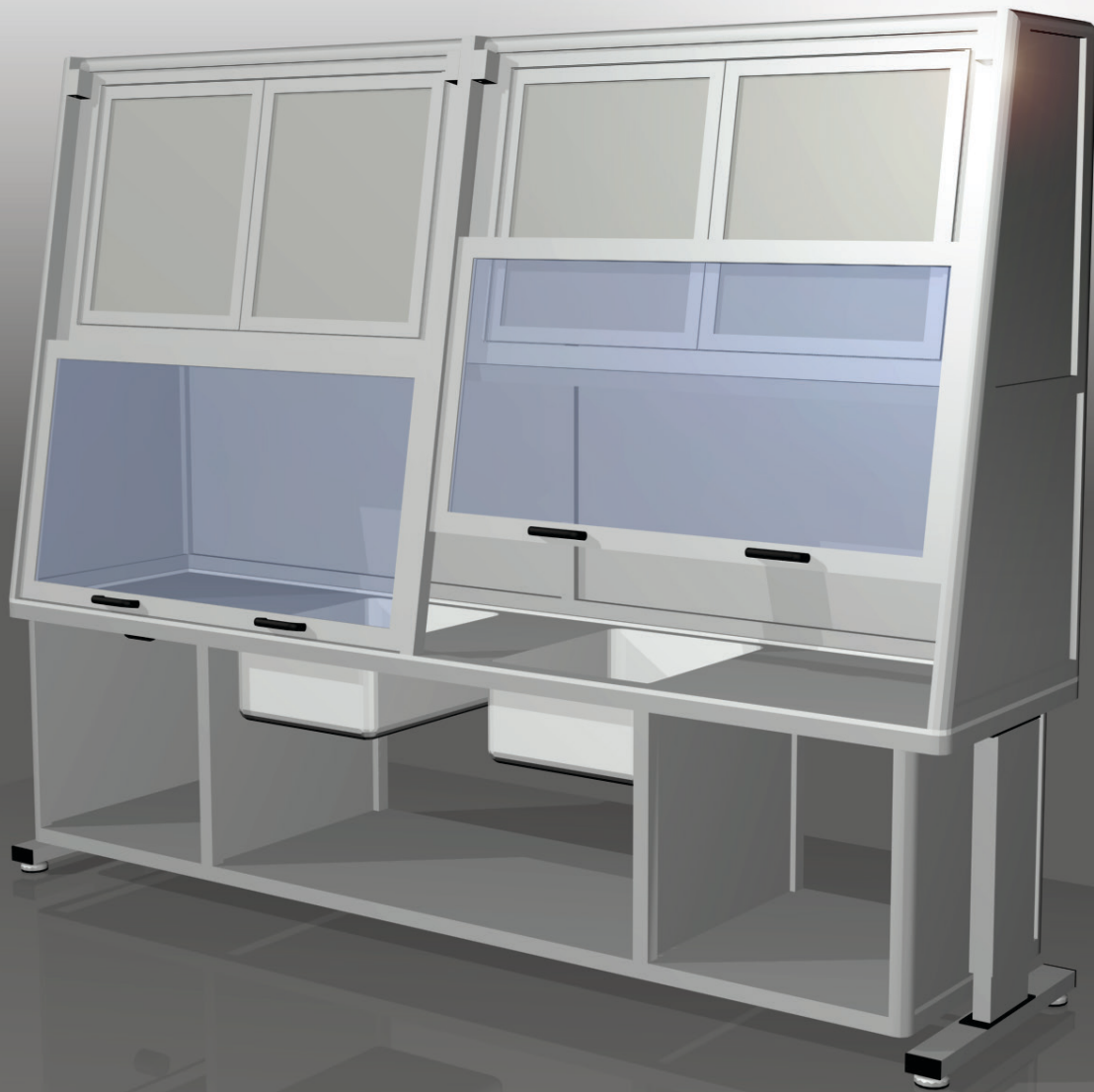

- Sugeskab med hejselåger, skrå front og hæve-/sænkefunktion
- Enclosure with vertical sliding doors, sloping front and height adjustable table

SYSTEM STANDEX A/S  
Herluf Trolles Vej 140 · 5220 Odense SØ  
Tlf.: 66 15 66 15 · Fax: 66 15 55 48  
info@system-standex.dk · www.system-standex.dk



**SYSTEM  
STANDEX®**